



YELLOWKNIFE Aquatic Centre

Concept Design Report
November 2020

Appendix C: Public Consultation Panels

Welcome!

The City of Yellowknife wants your input on a new aquatic centre.

As you move through the room, you'll find more information about the project, its history and next steps. Please pick up one of our surveys and fill in your responses on the following topics:

- 1 Are you in favour of a new aquatic centre with a 25m lane pool or a 52m lane pool?
- 2 Do you agree with the spaces & amenities proposed in the 2018 Aquatic Centre Pre-Design Plan?
- 3 Would you suggest any additional amenities?
- 4 Do you have any further comments or feedback?

Thanks for participating



YELLOWKNIFE
Aquatic Centre



WWW.YELLOWKNIFE.CA/AQUATICCENTRE

MJMA

#AquaticCentreYK

The City of Yellowknife is planning a new aquatic centre.

Here is a brief history of the project so far.

November 2016

City Council directs administration to pursue a \$12.9M federal grant for construction of a new aquatic centre

April 2018

Aquatics Centre Advisory Committee (ACAC) is formed. The City retains a consultant to prepare a PreDesign Plan

June 2018

Household surveys are undertaken to collect community feedback about the potential project

September 2018

Two preliminary concepts are presented to the community for feedback:

- 1) a new Aquatic Centre with a 25m lap pool
- 2) a Renovation/Addition to Ruth Inch Memorial Pool, with a new 25m lap pool and expanded support spaces

October 2018

PreDesign Plan is presented to Council including a recommendation from ACAC for a new Aquatic Centre with a 52m pool, based on public feedback. Capital cost is estimated at \$49.8M.

December 2019

City retains Taylor Architecture Group to finalize details of PreDesign Plan and (if approved) complete bridging documents for a Design-Build process

February 2020

Council instructs TAG to develop 2 concepts for the new Aquatic Centre:

- 1) a new Aquatic Centre with a 25m lane pool
- 2) a new Aquatic Centre with a 52m lane pool

March 2020

Public consultation is delayed due to COVID-19

now

Public consultation to determine:

25m or 52m pool?

November 2023

Construction is complete

April 2022

Construction begins

December 2021

Contract awarded to Design-Builder

October 2021

Public referendum for approval of funds

August 2021

Design-Builder selected

May 2021

Completion of bridging documents & issuance of Design-Build RFP

November 2020

Council decision on recommended option

October 2020

TAG to submit concept plans and recommendation based on public feedback



YELLOWKNIFE
Aquatic Centre



WWW.YELLOWKNIFE.CA/AQUATICCENTRE

MJMA

#AquaticCentreYK

Why do we need a new aquatic centre?

Ruth Inch Memorial Pool cannot accommodate the current demand for aquatic programming.

From 2017 to 2019, an annual average of **825 people were waitlisted** for programs at the pool. That's a ratio of **more than 1 in 4** applicants being put on a waitlist.

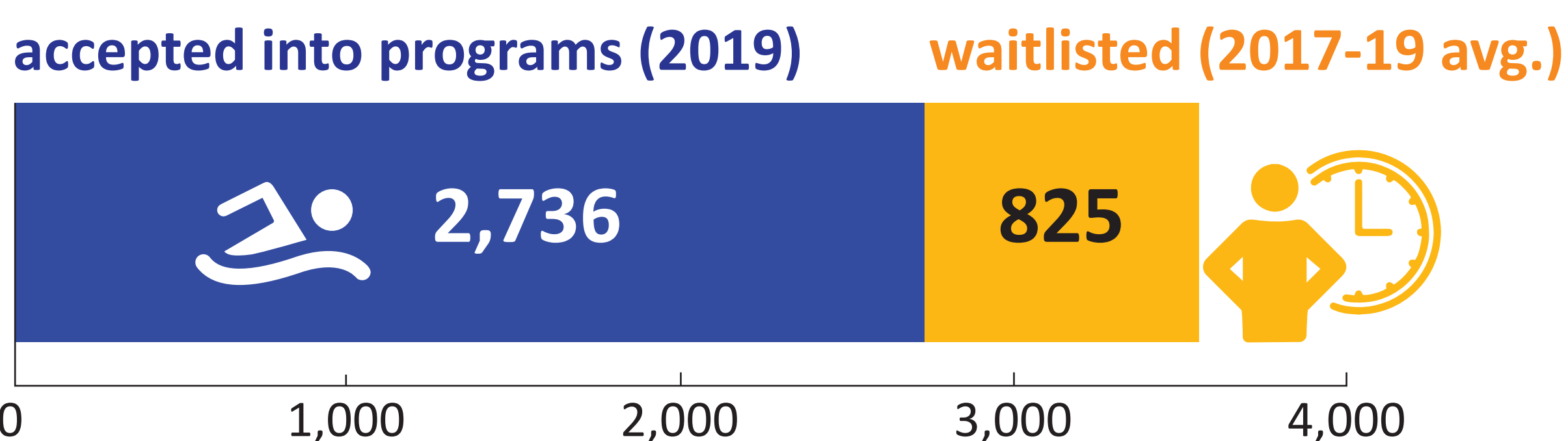

The pool is one of the most-used recreation facilities in Yellowknife.

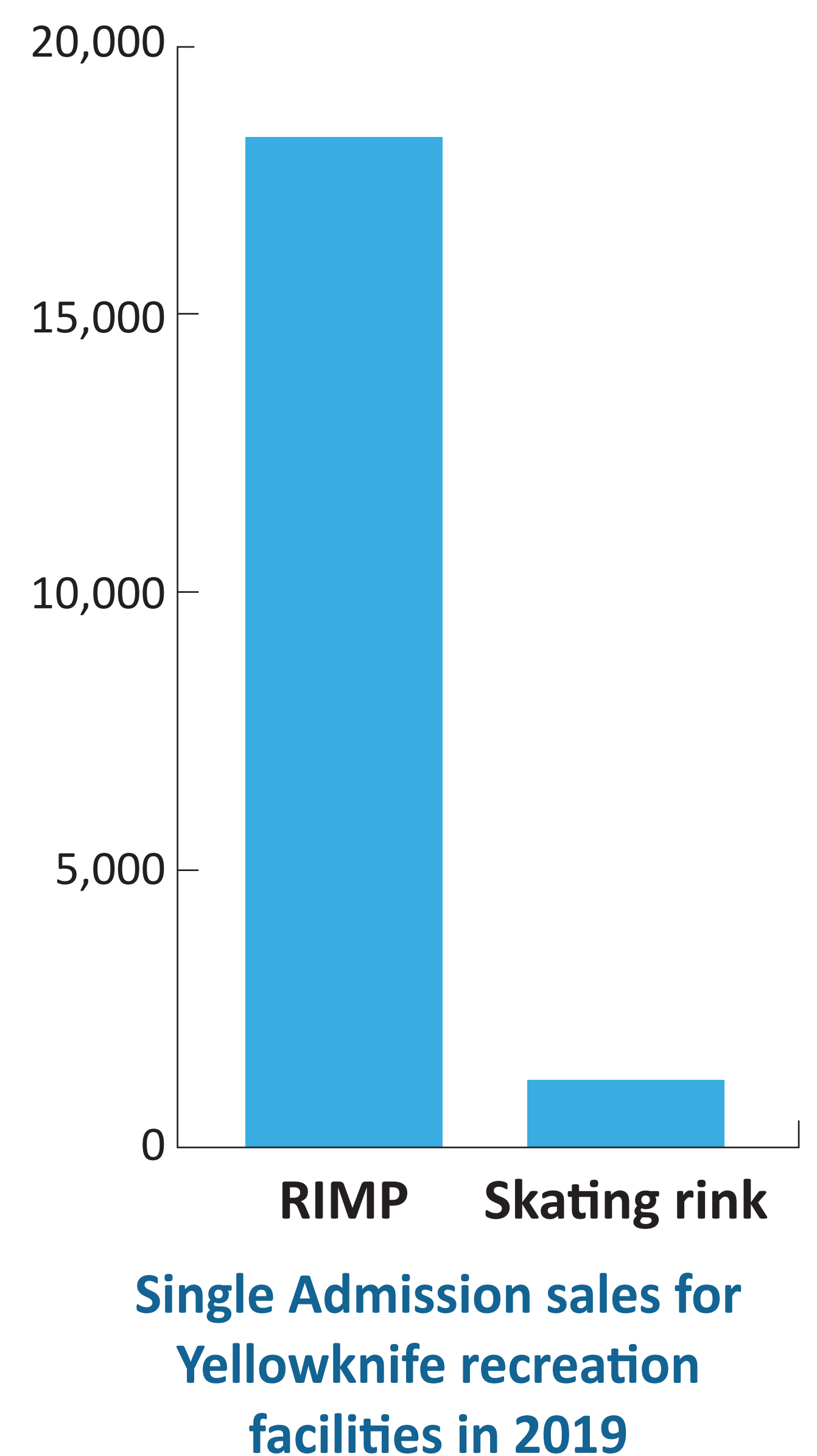

In 2018, only 52% of households expressed satisfaction with the current facility.

Based on survey responses from 425 Yellowknife households, the #1 issue cited about the pool was:

“It doesn’t have the amenities desired”
— 41% of respondents

Residents also cited the following issues as preventing them from using the pool more often:

- The water is too cold
- The pool is crowded
- It is very difficult to register my child for swimming lessons

Each of these issues is largely related to the insufficient size of the existing facility.

RIMP is an aging facility that requires significant upgrades.

Why can't we just renovate Ruth Inch Memorial Pool?

Ruth Inch Memorial Pool requires extensive renovations, plus an addition if it is to meet current demand.

The facility requires a full envelope retrofit and replacement of building systems. **Construction could take up to 2 years**, during which time the pool would be closed to the public.

Several key issues with RIMP would not be resolved unless a sizable addition is built:

- limited capacity and long wait lists
- cramped changerooms
- water temperature – often too cold for leisure swimmers because the single basin is shared with lane swimmers

Renovating RIMP would be a significant investment (into aging infrastructure).

Estimated cost to renovate with no addition: **\$ 8 – 14 M**

Estimated cost to renovate + add a 25m lane pool: **\$ 26 – 43 M**

The City of Yellowknife has been approved for a Federal grant of \$12.9M to build a NEW pool.

This funding cannot be accessed for a renovation project.

The exponentially increasing cost of construction means the best time to build is now.

A full renovation could increase the building's lifespan by 20 years — but by that time, the cost of building a new aquatic centre will likely have **more than doubled**.

Historical construction costs (\$/m²) for NWT school facilities

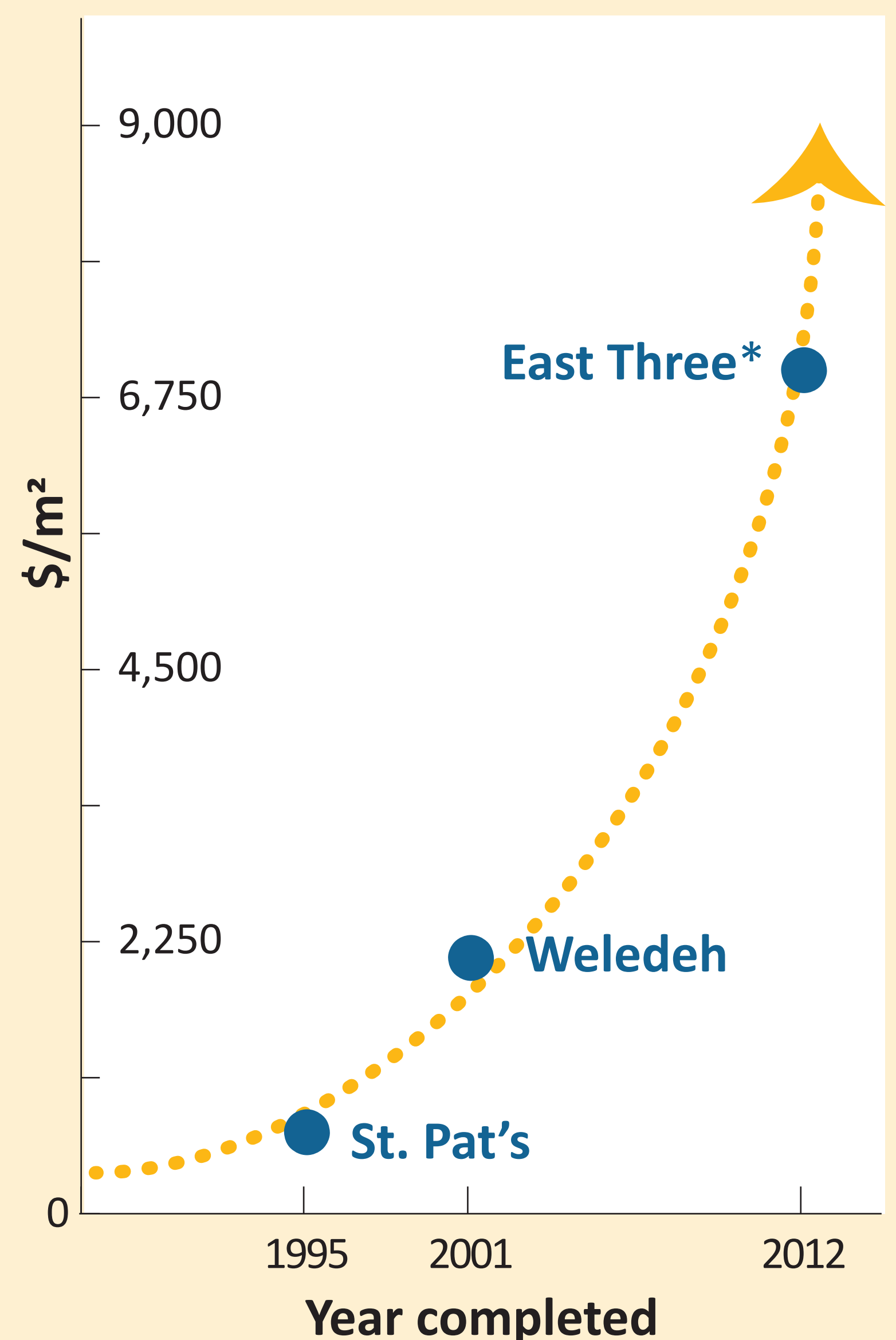

* East Three school is located in Inuvik. For accurate comparison to Yellowknife schools, the construction cost shown here has been reduced by a factor of 1.3



What did the aquatic centre pre-design plan recommend?

In 2018 a survey was done of 425 households and 42 community organizations to determine what programs should go into Yellowknife's new aquatic centre. The surveys were used by the Aquatic Centre Advisory Committee to generate a pre-design report with recommended programs, outlined below.

Natorium (Pool Area)

Lane Pool

- 25m or 52m
- Lessons
- Lane swim
- Deep end for scuba, synchro, etc

Leisure Pool

- Zero depth entry
- Play and spray features
- Lazy river
- 3 lanes of 25m
- Splash deck
- Hot tub

Sauna and Steam Room

- Therapeutic and recreational

Change rooms

- Universal design

Public Spaces

Lobby

- Access to control points
- Enable viewing to leisure pool

Family Viewing

- Viewing to watch swim lessons
- Spectator viewing of lap pool

Multipurpose Rooms

- Flexible division of space
- Accommodate courses
- Dry-land warm-up
- Birthday parties

Additional Spaces

Staff Areas

- Administration space
- Staff room
- First aid room

Storage

- Pool equipment
- Aquatic club storage

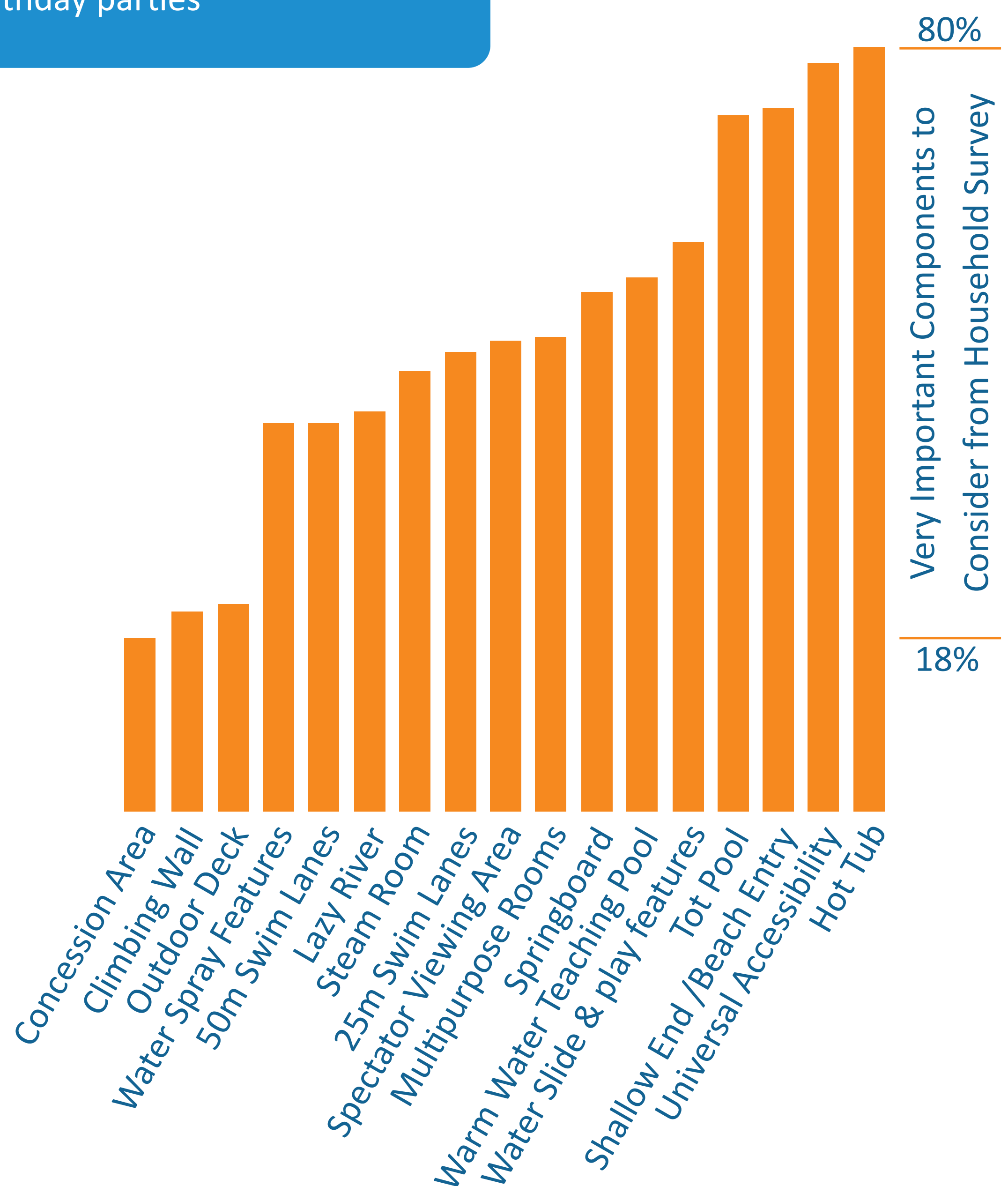

What benefits can a new aquatic centre bring to Yellowknife?

Health

Pools are a great place to stay active. Both hot tubs and leisure pools can also help with relaxation, healing, physiotherapy and rehabilitation. Having access to a second basin, with warmer water temperature, would greatly improve these opportunities for Yellowknifers.

Education & Safety

Aquatic centres are spaces for both **recreation** and **education**. Programs and courses offered at the new pool may include:

- Rescue training and First Aid
- Swimming lessons
- Scuba dive certification
- Lifeguard training

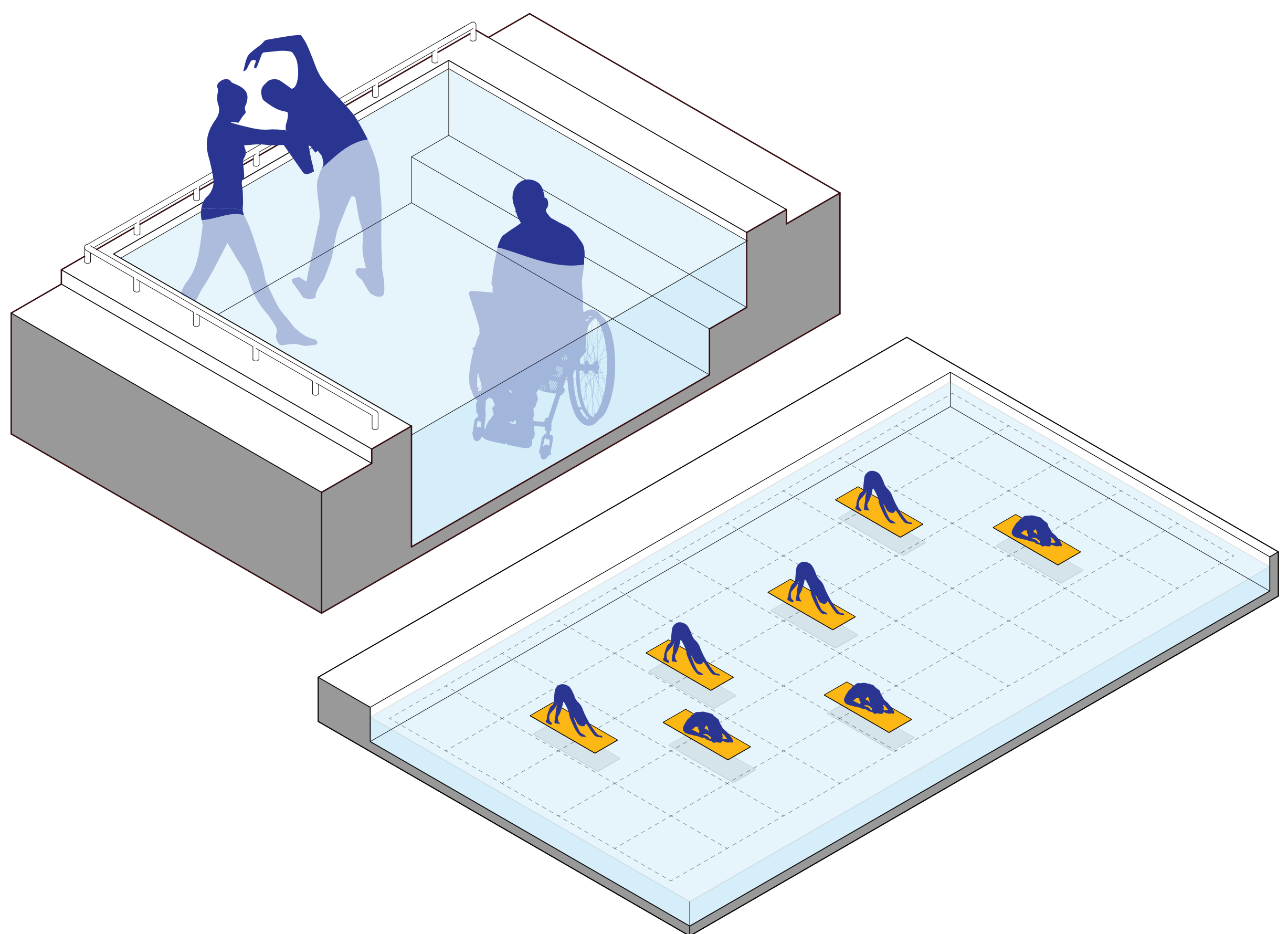

Community

Pools are **community spaces**. As a northern city, Yellowknife's recreation centres are essential to public health and wellbeing, especially during the long winter months.



YELLOWKNIFE
Aquatic Centre



WWW.YELLOWKNIFE.CA/AQUATICCENTRE

MJMA

#AquaticCentreYK

What goes in an aquatic centre?

An aquatic center is home to a lot of different spaces that help to engage the community in multiple ways. The natatorium (pool space) can be used for competitive and leisure activities, and the rest of the facility incorporates spaces for community gatherings and engagement.

Universal Change Rooms:

Modern facilities provide a single locker space with individual, private changing rooms. This makes change rooms safer and more accommodating for everyone.

Spectator Seating:

There can be additional seating in the natatorium, providing space for friends and family to view aquatic activities.

Lobby:

The lobby accommodates the needs of the staff and the public, providing space for gathering and the viewing of aquatic activities.

Mechanical Room:

A lot of equipment is required to ensure the safety and quality of the pool environments.

Natatorium:

There are multiple factors to consider when selecting the types of pools that go in an aquatic centre. Lap pools are typically built in 25m or 50m lengths to accommodate competitive events and large activities.

Leisure and therapy pools provide warmer and shallower water to accommodate more recreational activities and age groups.

Multipurpose Rooms:

Multipurpose rooms provide space for activities, teaching, community groups and clubs - maximizing the use of the building.

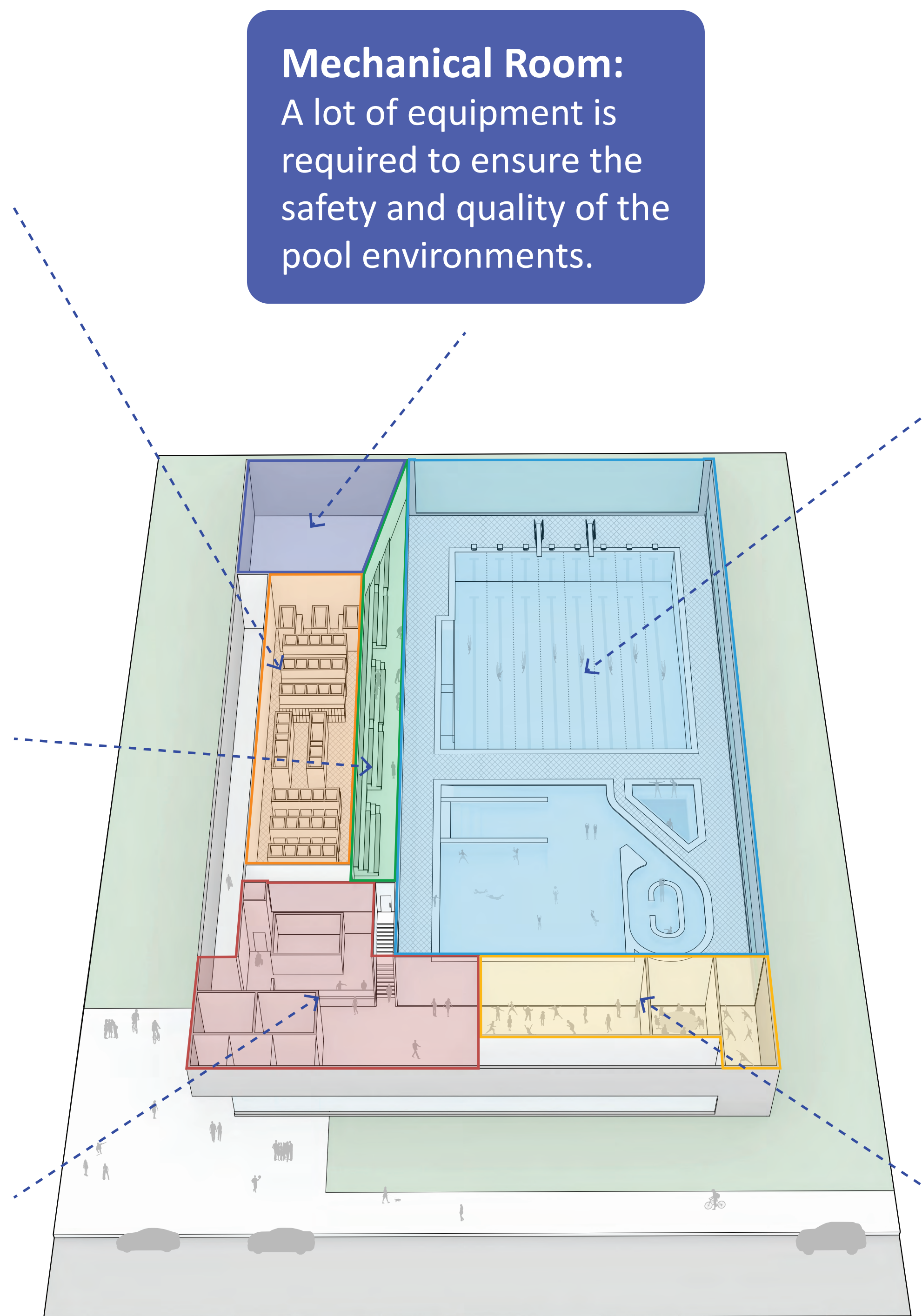

YELLOWKNIFE
Aquatic Centre

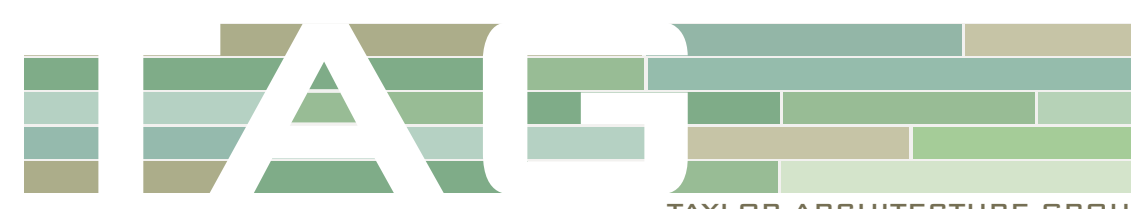

WWW.YELLOWKNIFE.CA/AQUATICCENTRE

MJMA

#AquaticCentreYK

How can an aquatic centre be more flexible?

Through the use of adjustable bulkheads and ropes pools can adapt to different activities. This allows multiple user groups to utilize a single space!

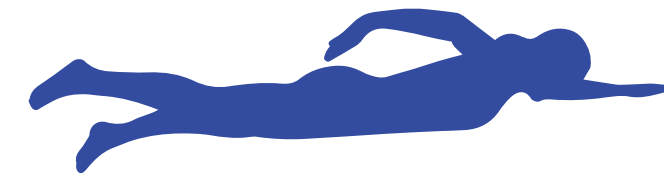

Adjustable Bulkheads (50m Pool)

One Basin

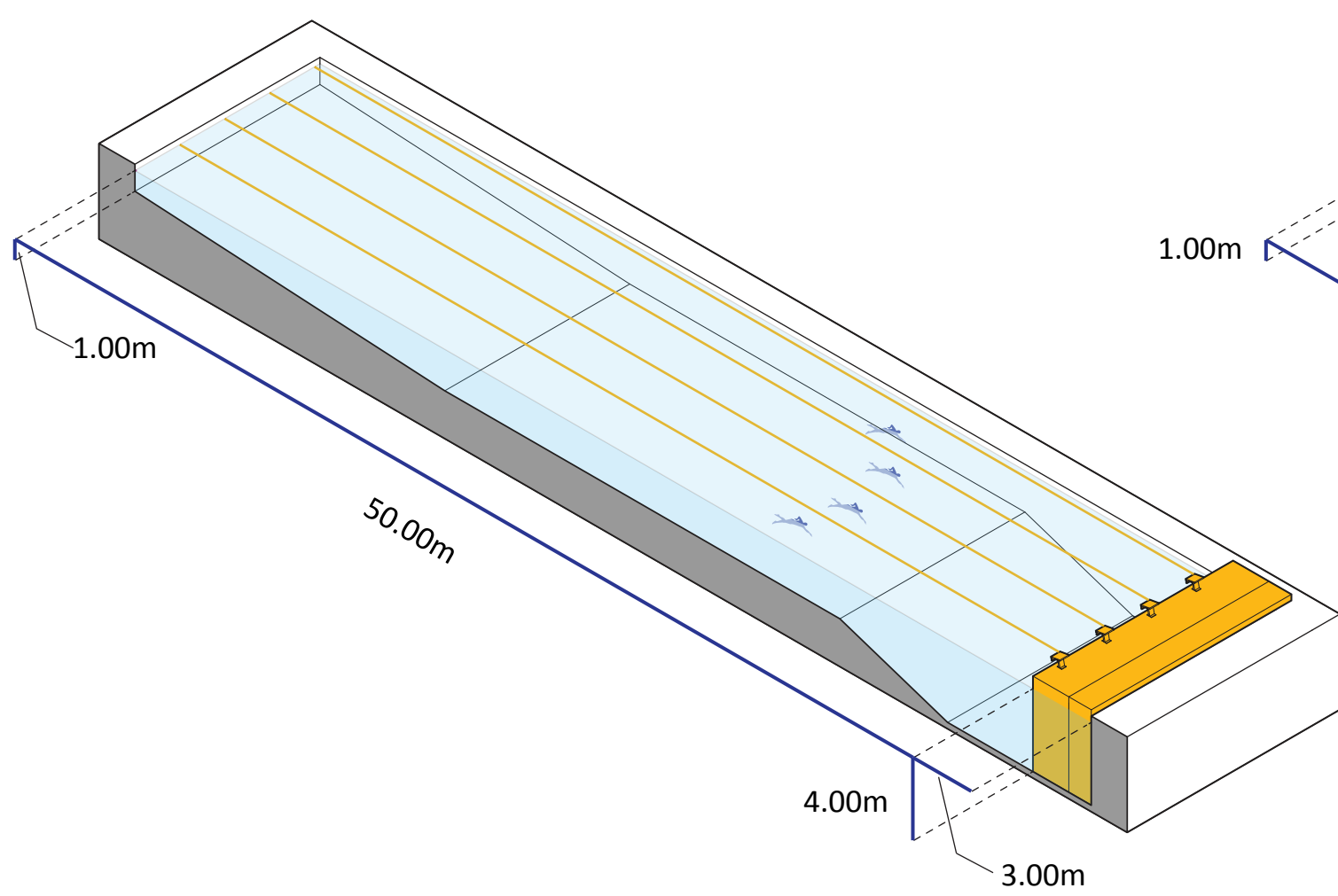

50m lane pool

Two Basins

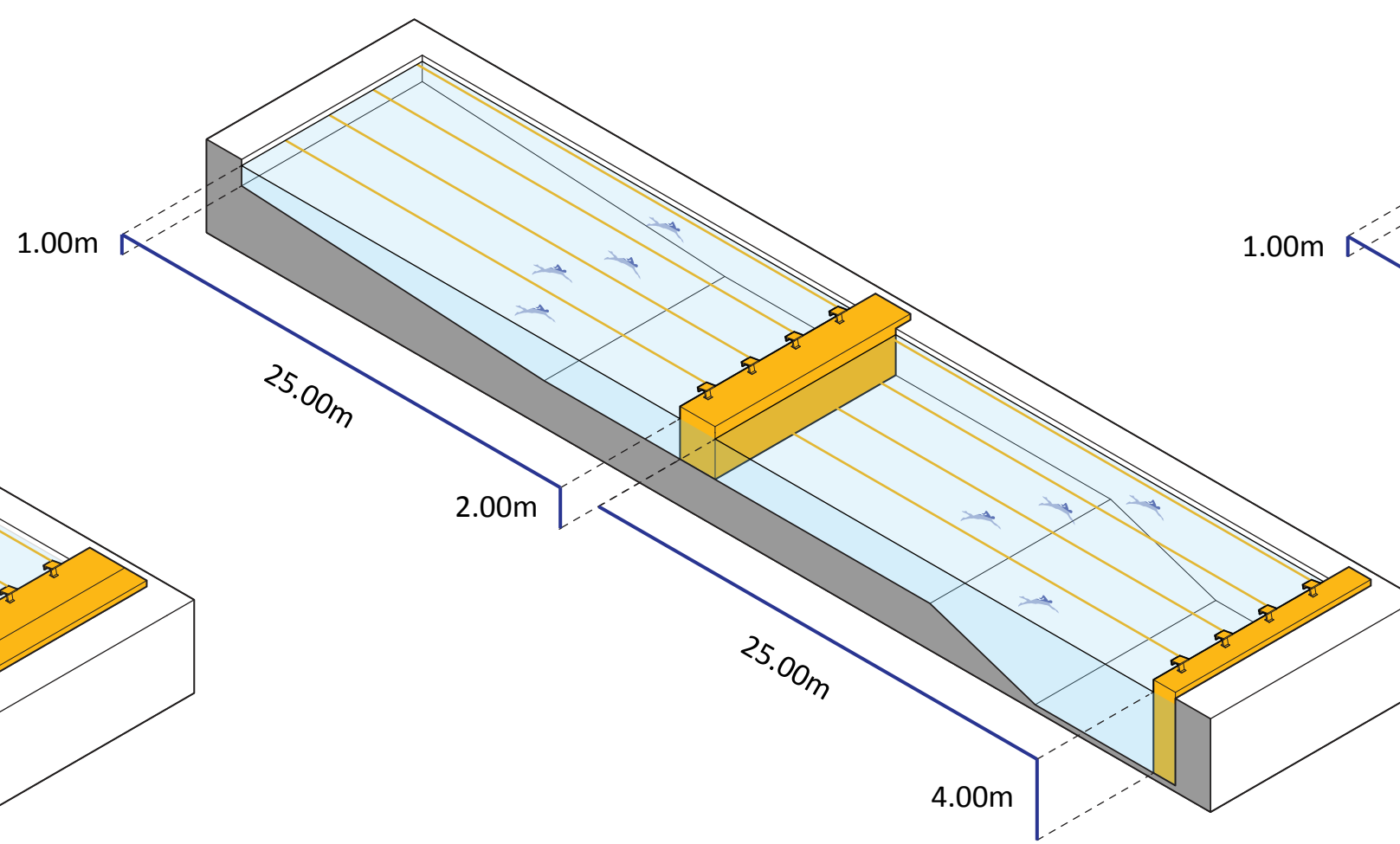

Two 25m lane pools

Three Basins

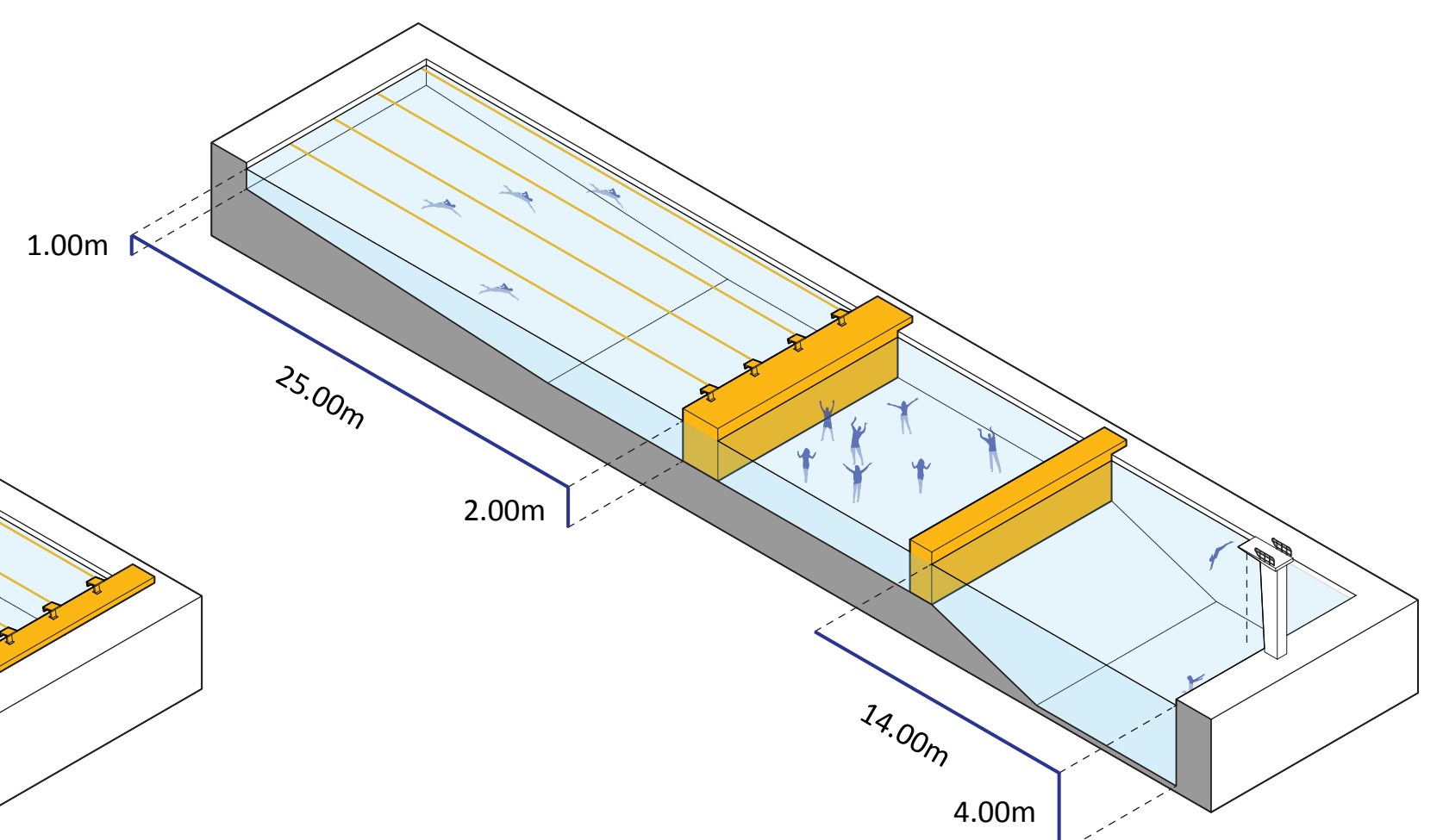

25m lane pool, free activity space, and diving pool

Rope Division

One Activity

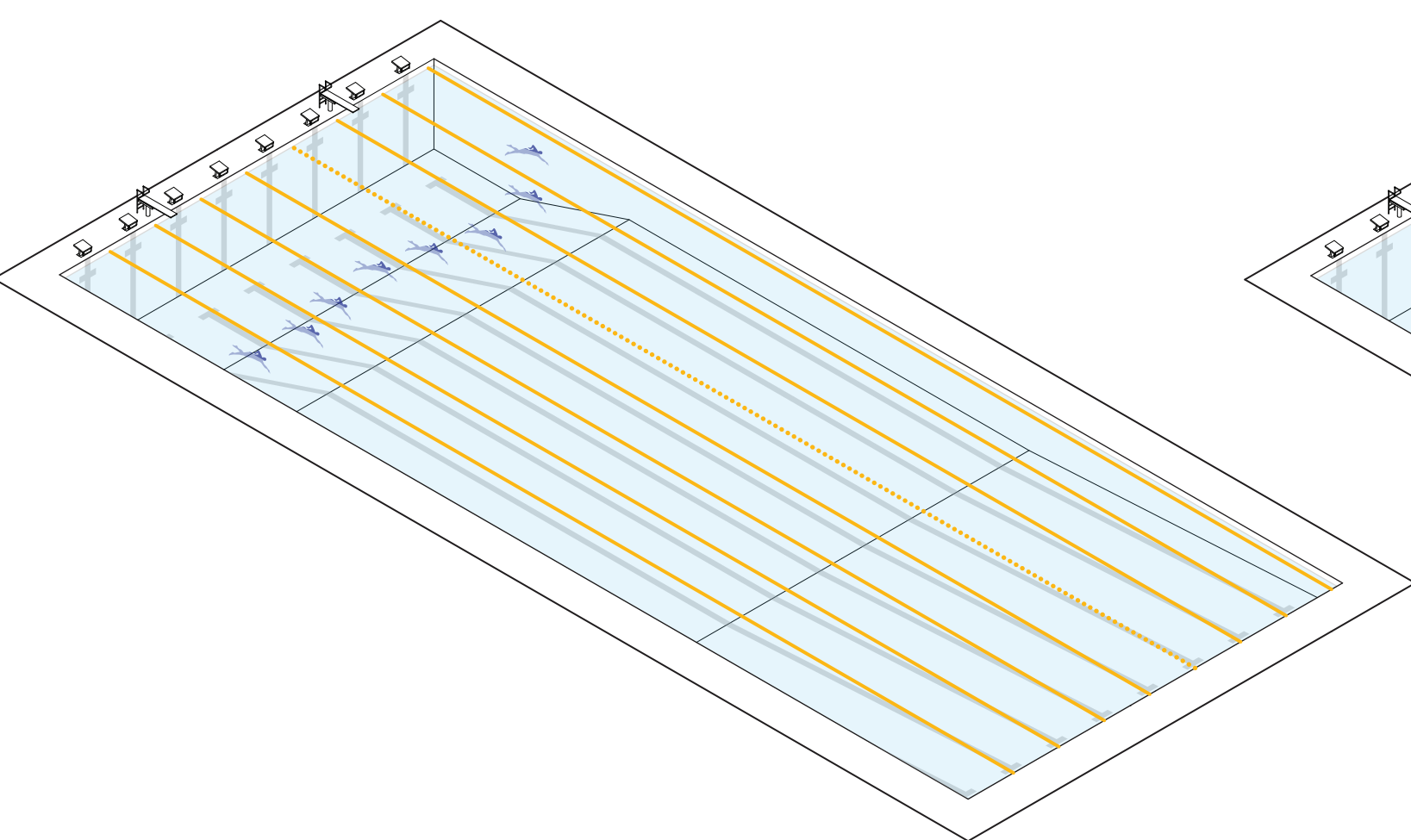

Large activities that require the full area of the pool such as competing in races.

Two Activities

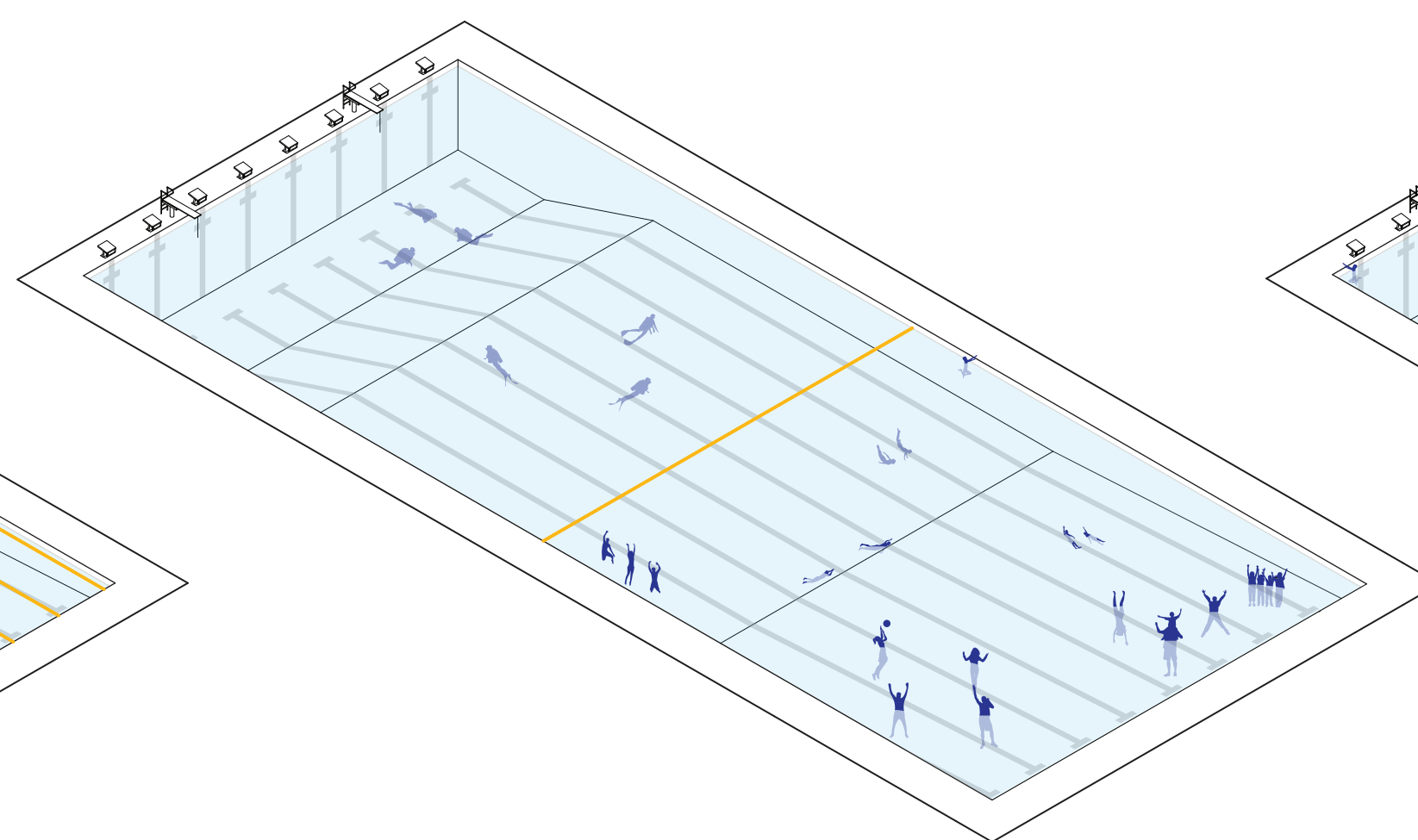

Allows the pool to be used for multiple user groups that require large amounts of space.

Three or More Activities

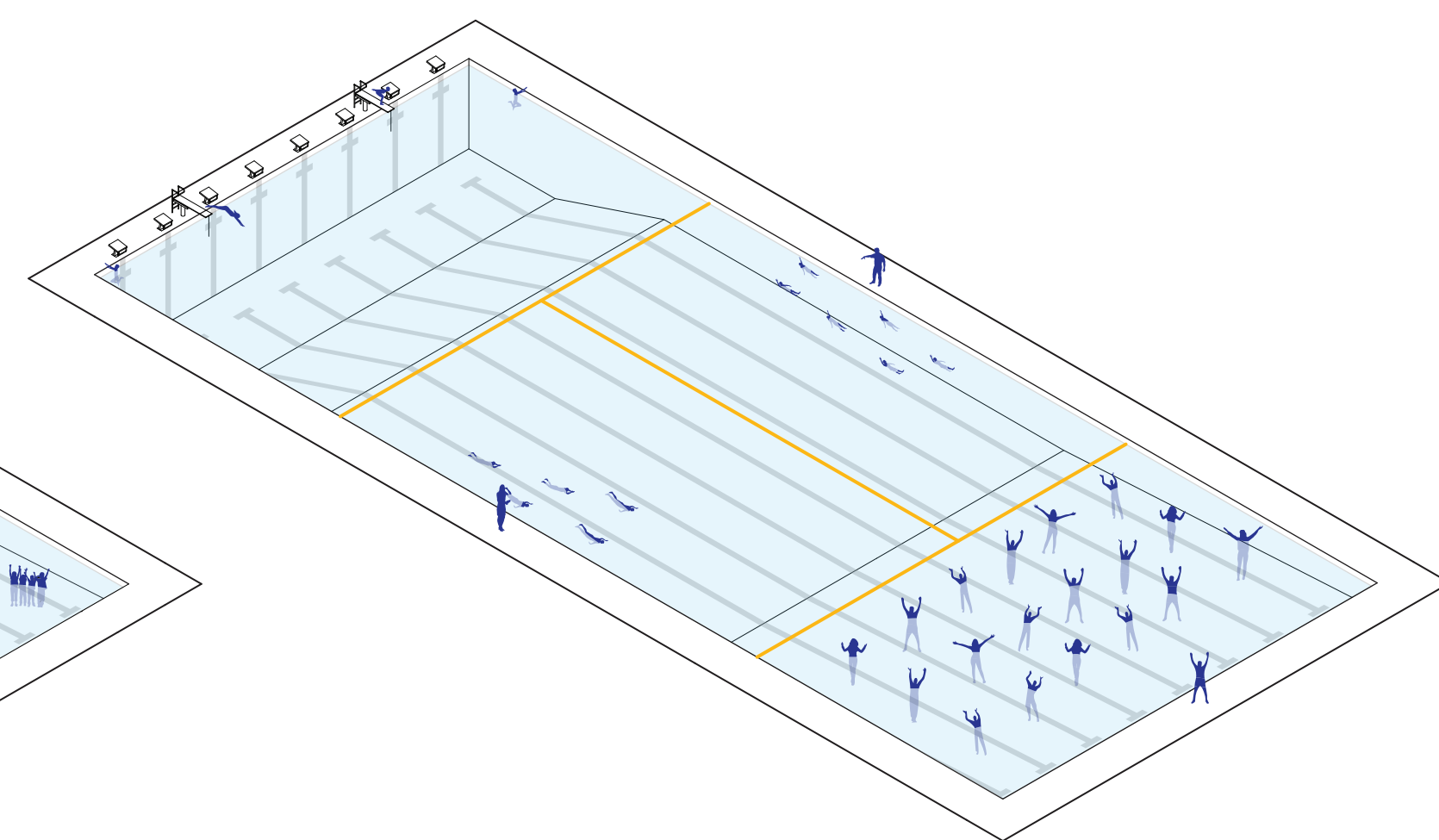

Endless numbers of divisions allow the pool to be used to its full potential.



YELLOWKNIFE
Aquatic Centre

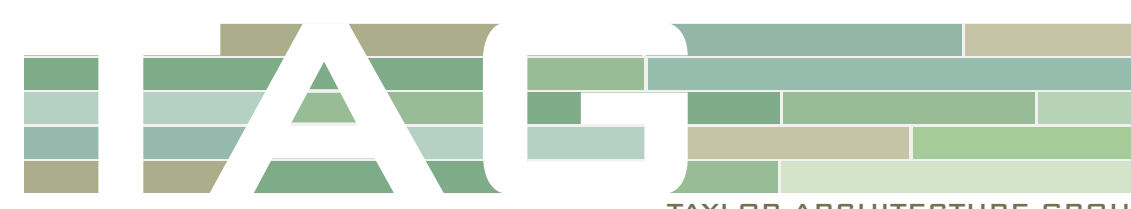

WWW.YELLOWKNIFE.CA/AQUATICCENTRE



#AquaticCentreYK

What leisure activities can go in an aquatic centre?

There are a lot of different leisure activities that occur in an aquatic centre. They can help you stay active, feel better, or just have fun! The activities can take place in the warmer water of the leisure pool or in the lane pool which typically has areas of greater depth.



Climbing Wall



Lazy River



Recreational Sports



Pool Side Slides



Learn to Swim Instruction

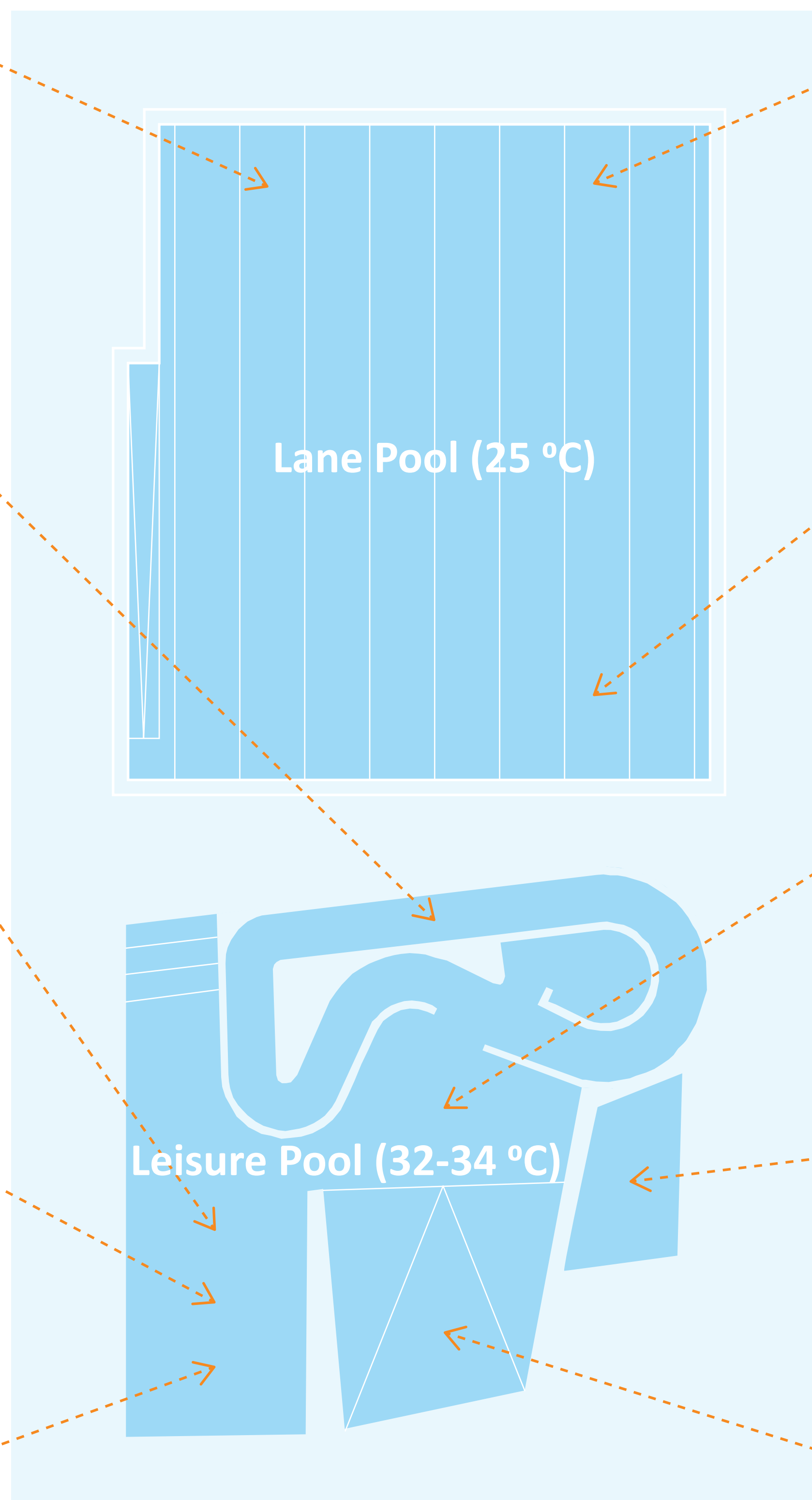

Diving



Wellness Activities



Spray Features



Hot Tub/ Therapy Pool (33-40°C)



Shallow / Beach Entry

What else can go in an aquatic centre?

There are many additional activities that can occur in an aquatic centre that can help activate the space and attract a larger variety of people. Some can happen within the existing footprint of the pool, and some require additional space.

Climb! Inflatable Obstacle

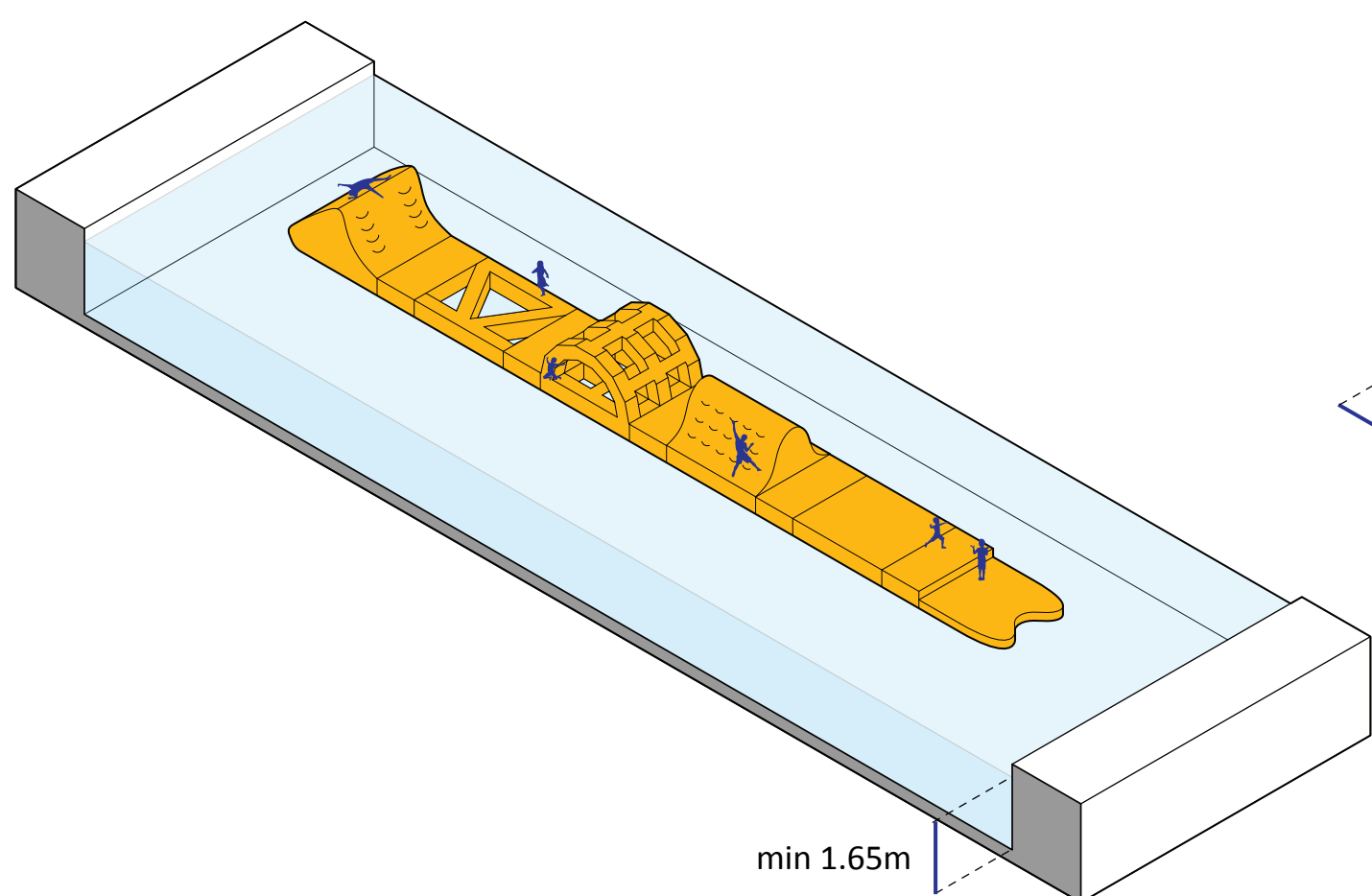

Hang! Retractable Race Course

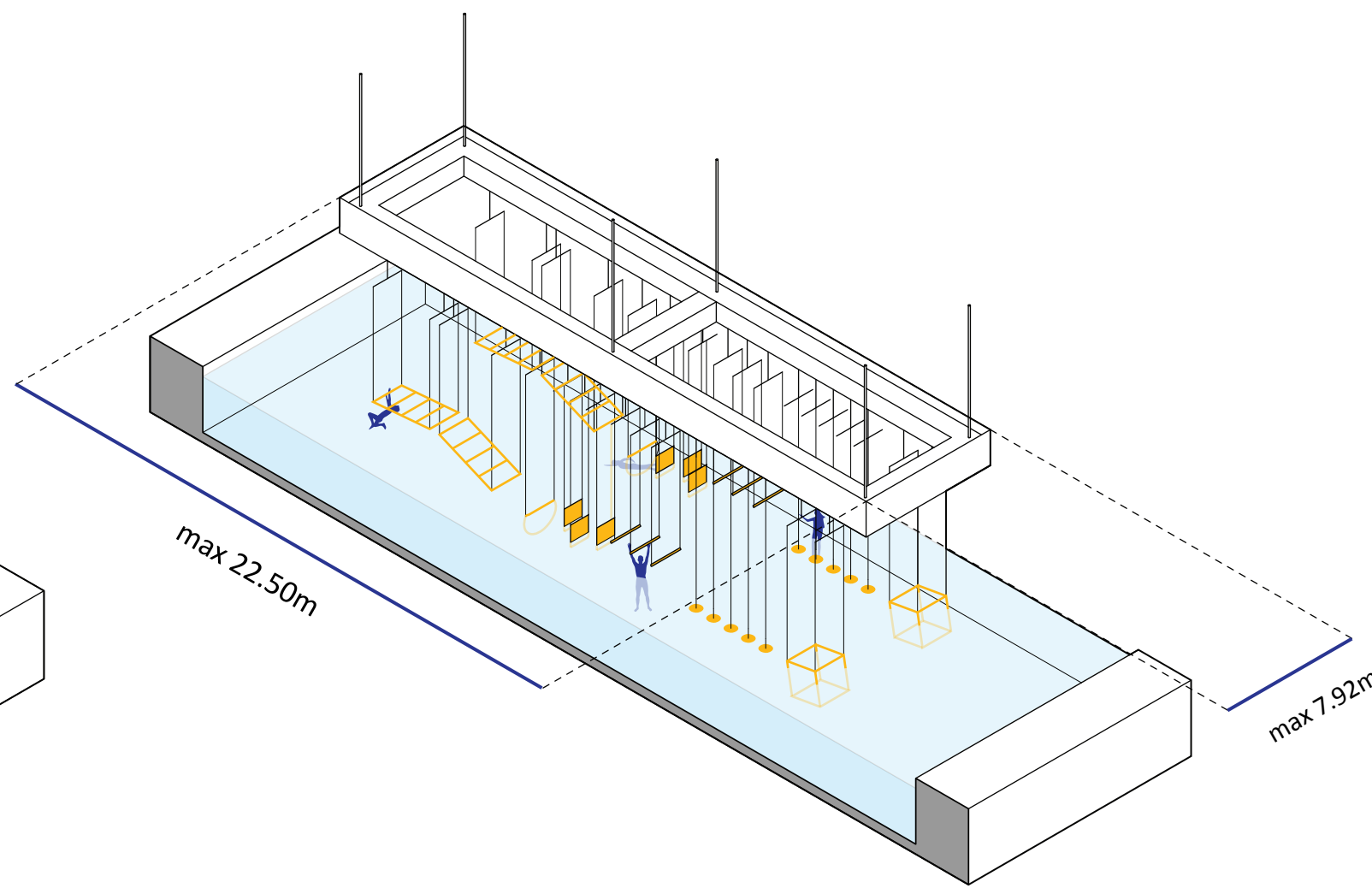

Swing! Tarzan Rope

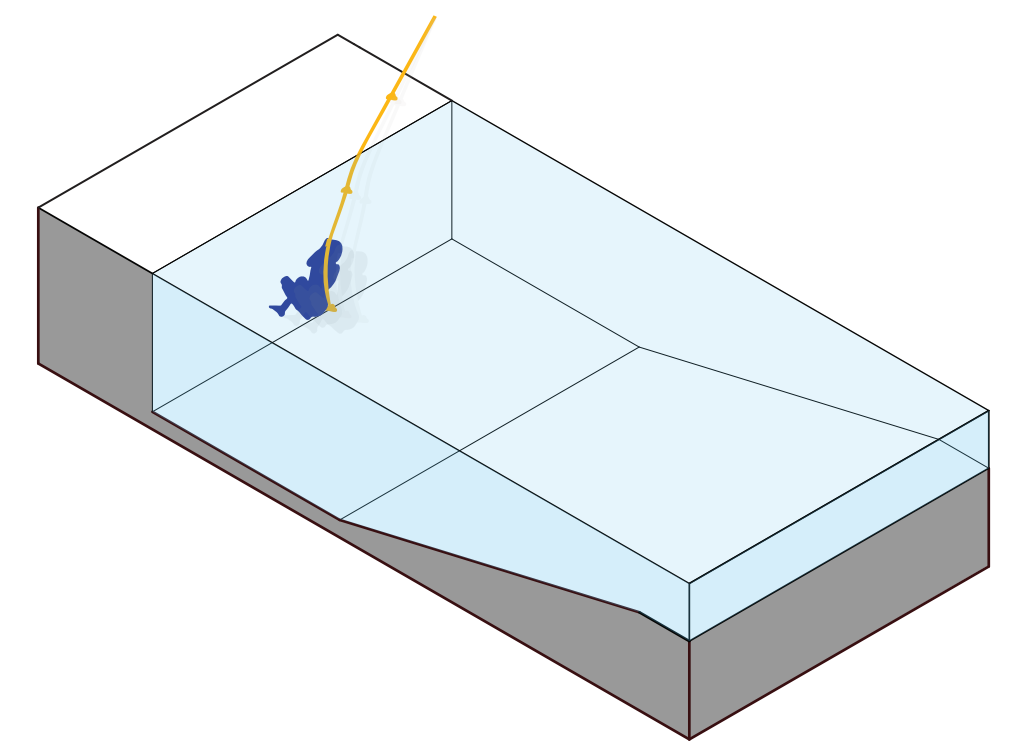

Slide! Large Pool Slides

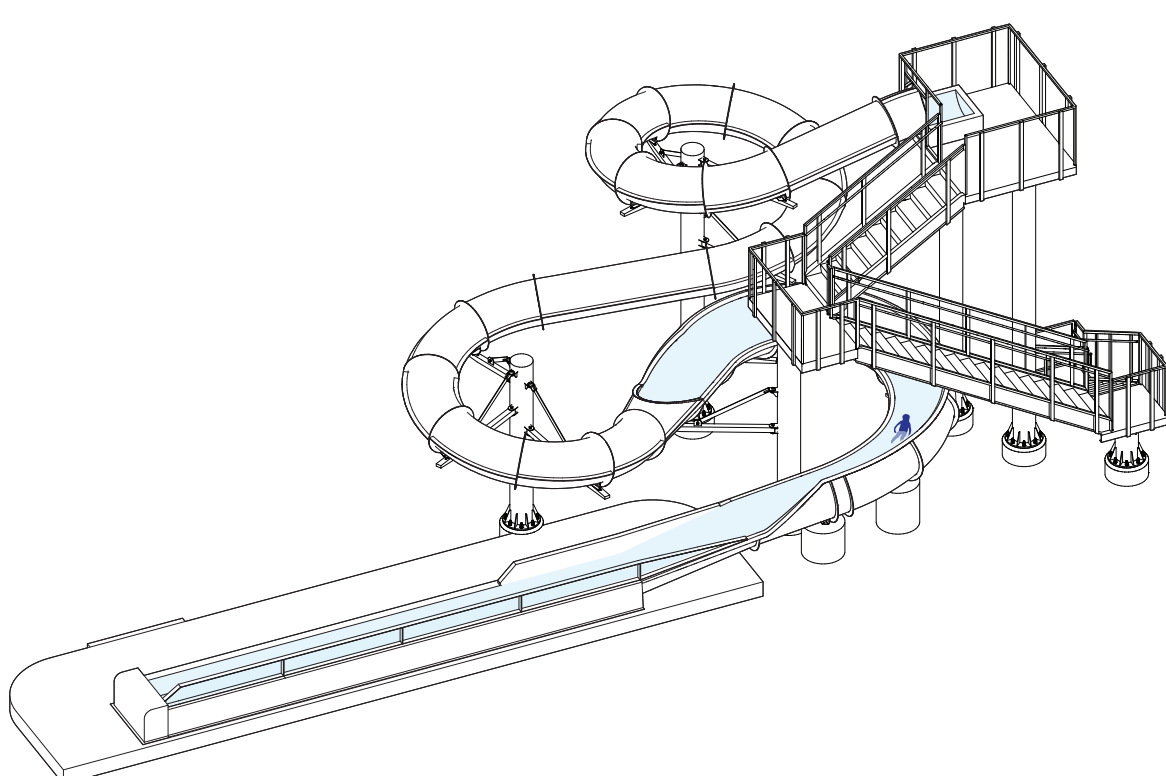

Business! Rental Space

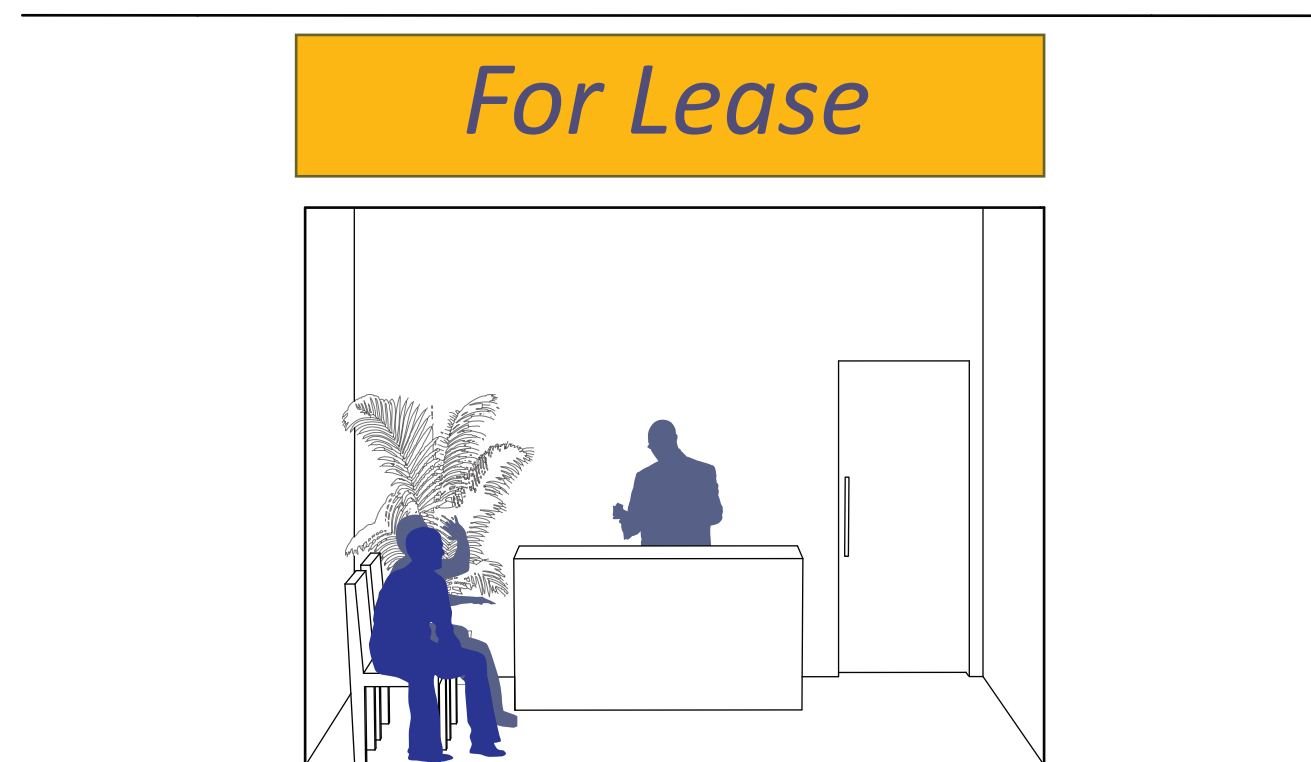

Play! Splash Pad

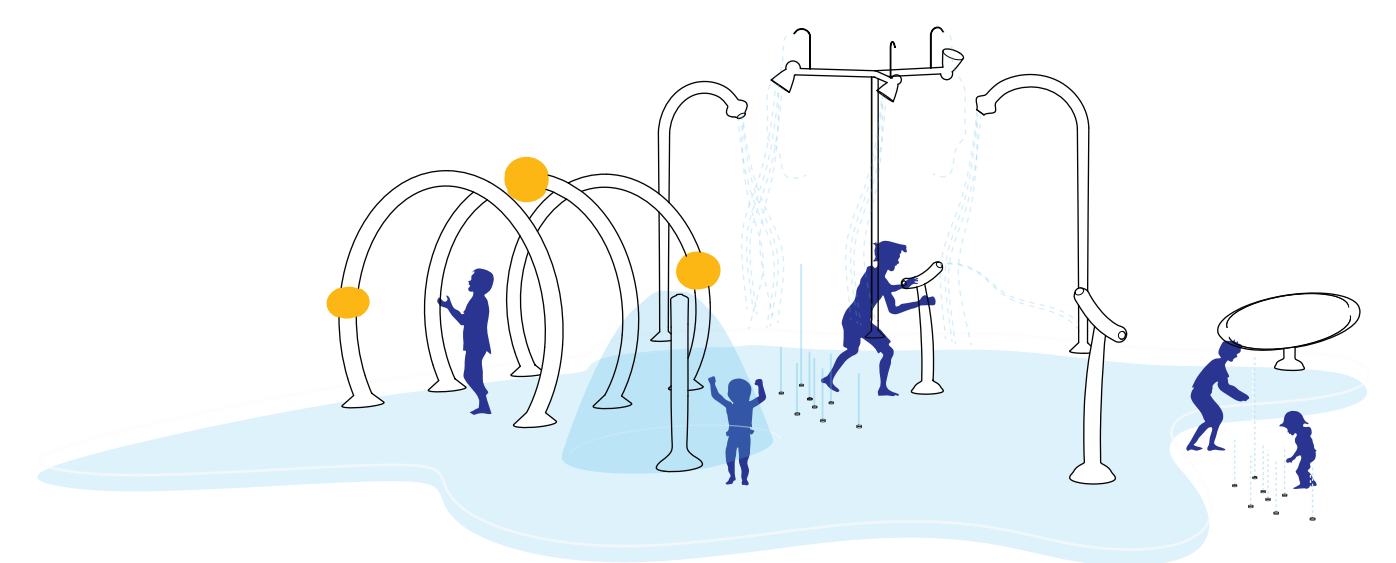

What activities can you do in a 25m pool?

25m pools are big enough to accommodate almost any aquatic activity. They are capable of hosting races as well as a variety of other leisure activities. The only activities you can not do in a 25m pool are water polo competitions, synchronized swimming competitions and 50m races.

Race! 25m Short Course

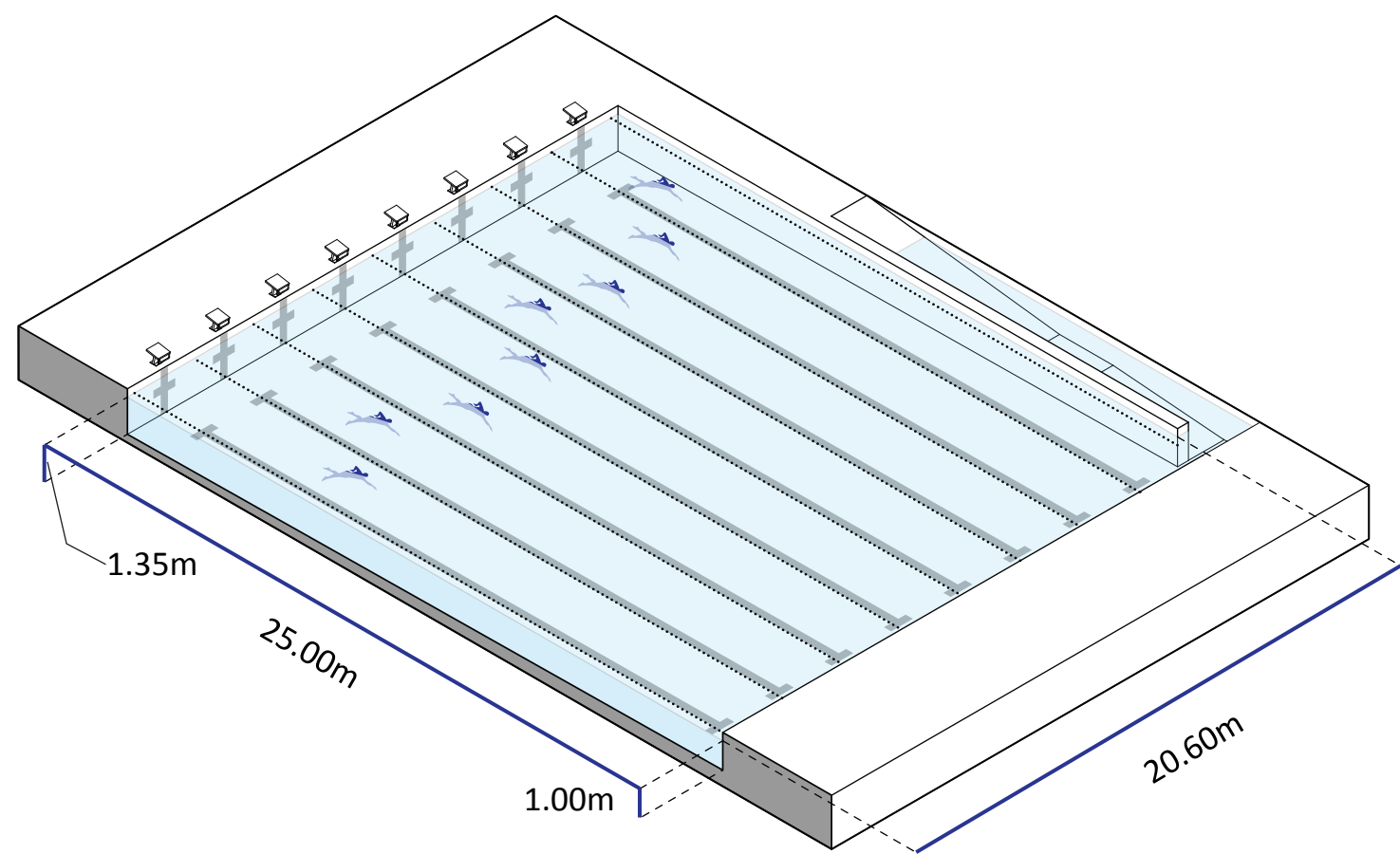

Rescue! Lifesaving Sport

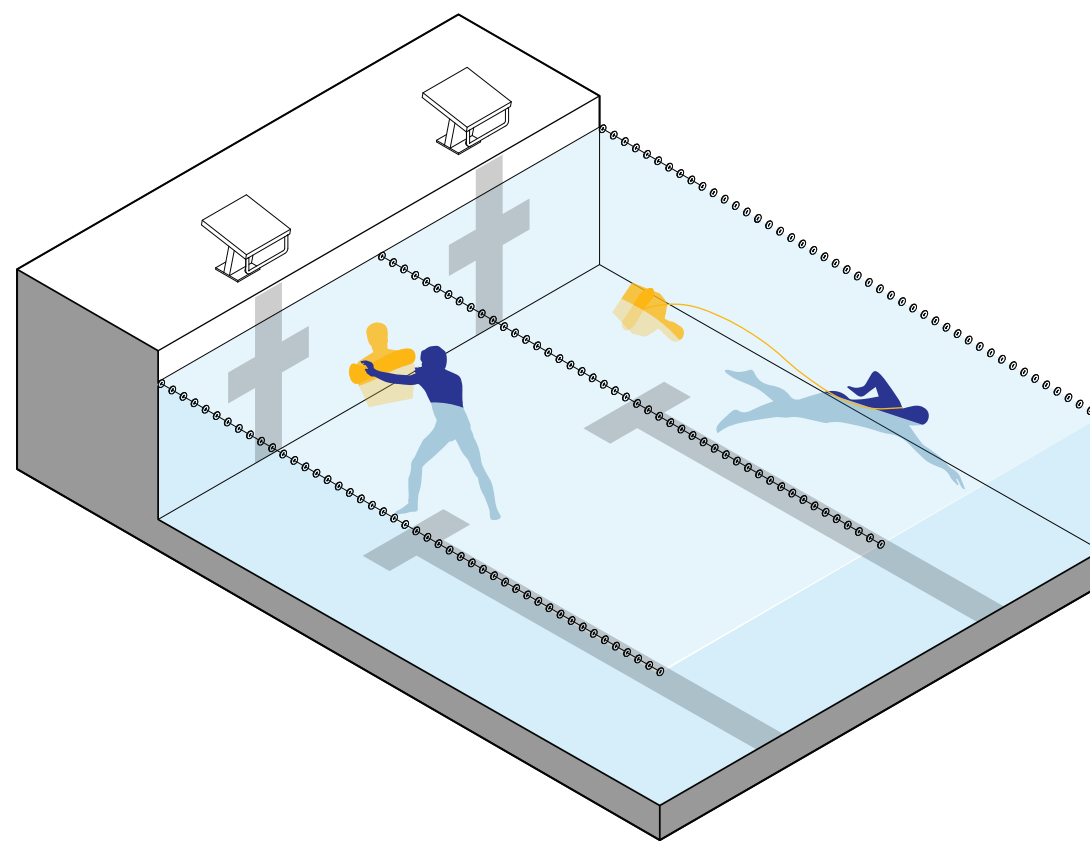

Paddle! Kayaking

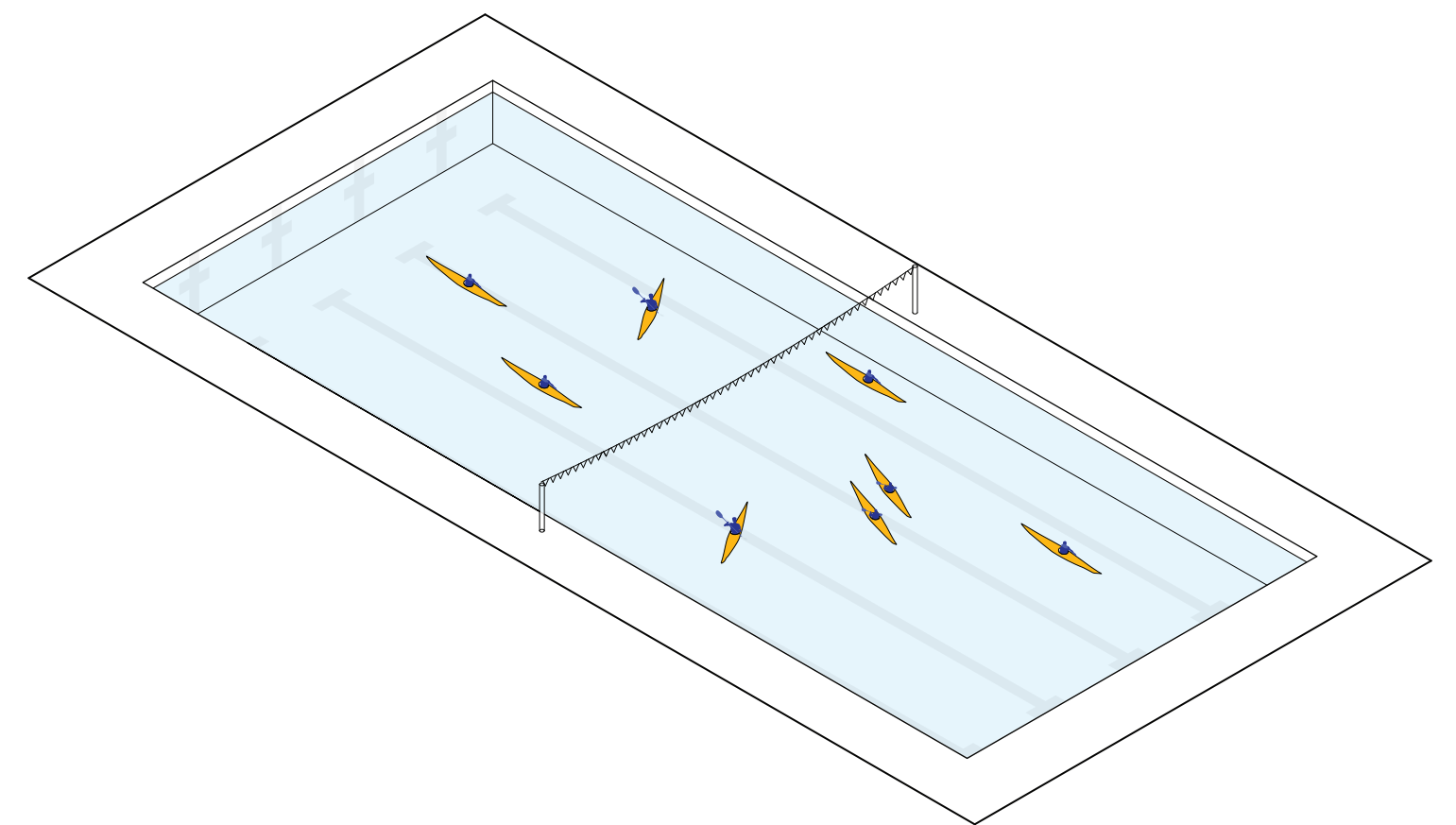

Hockey! Underwater Hockey

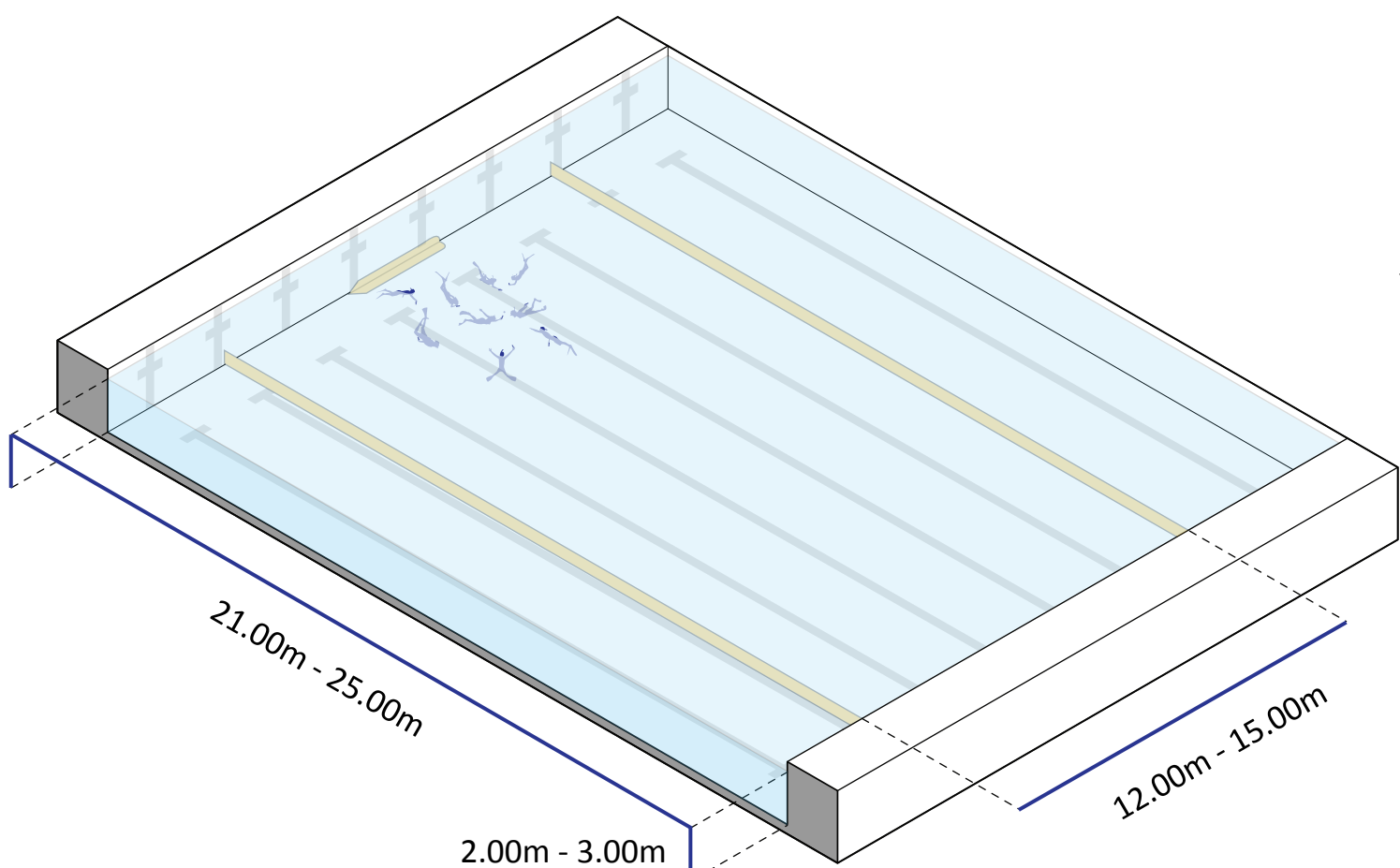

Battle! Dragon Boat Racing

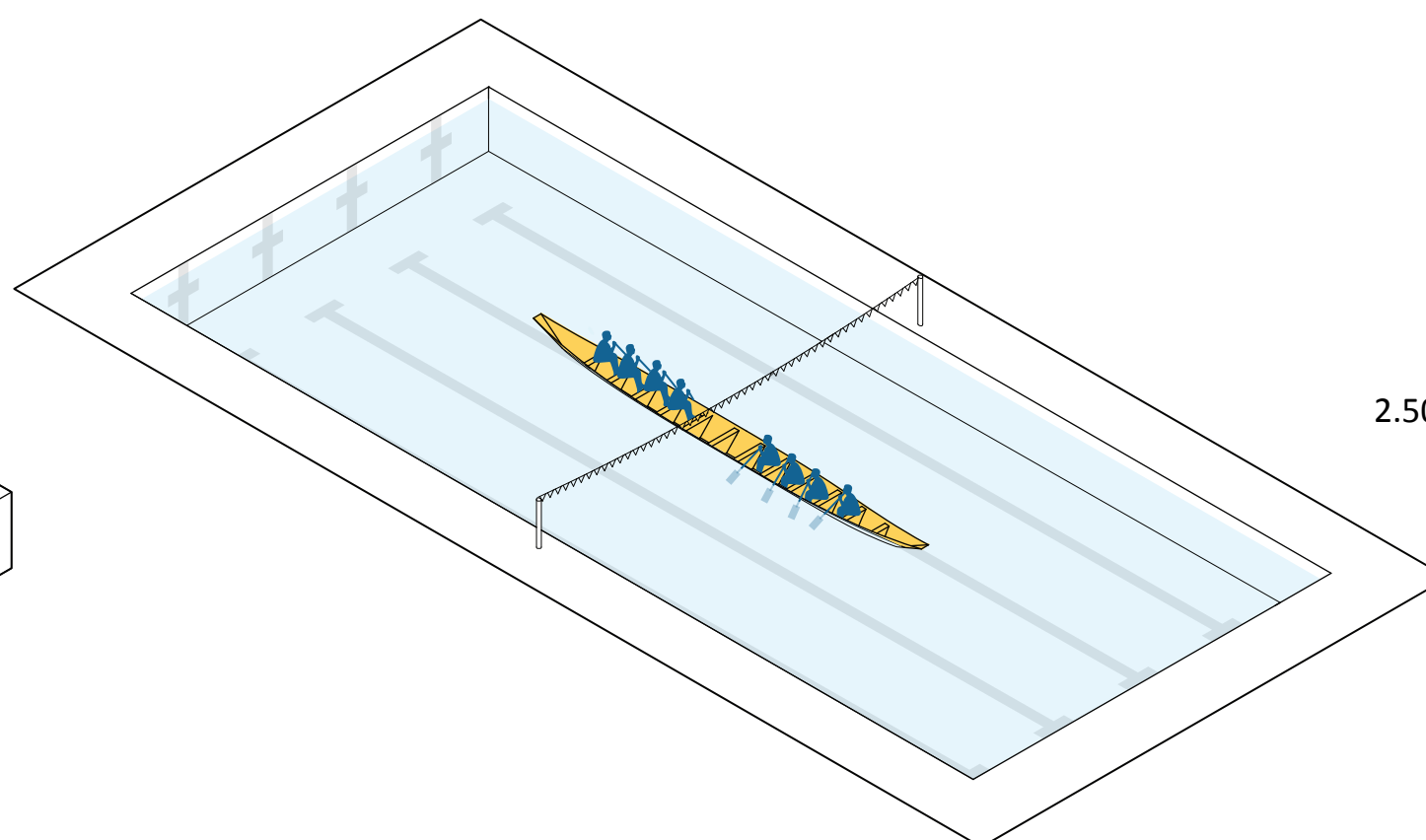

Dive! Scuba Lessons

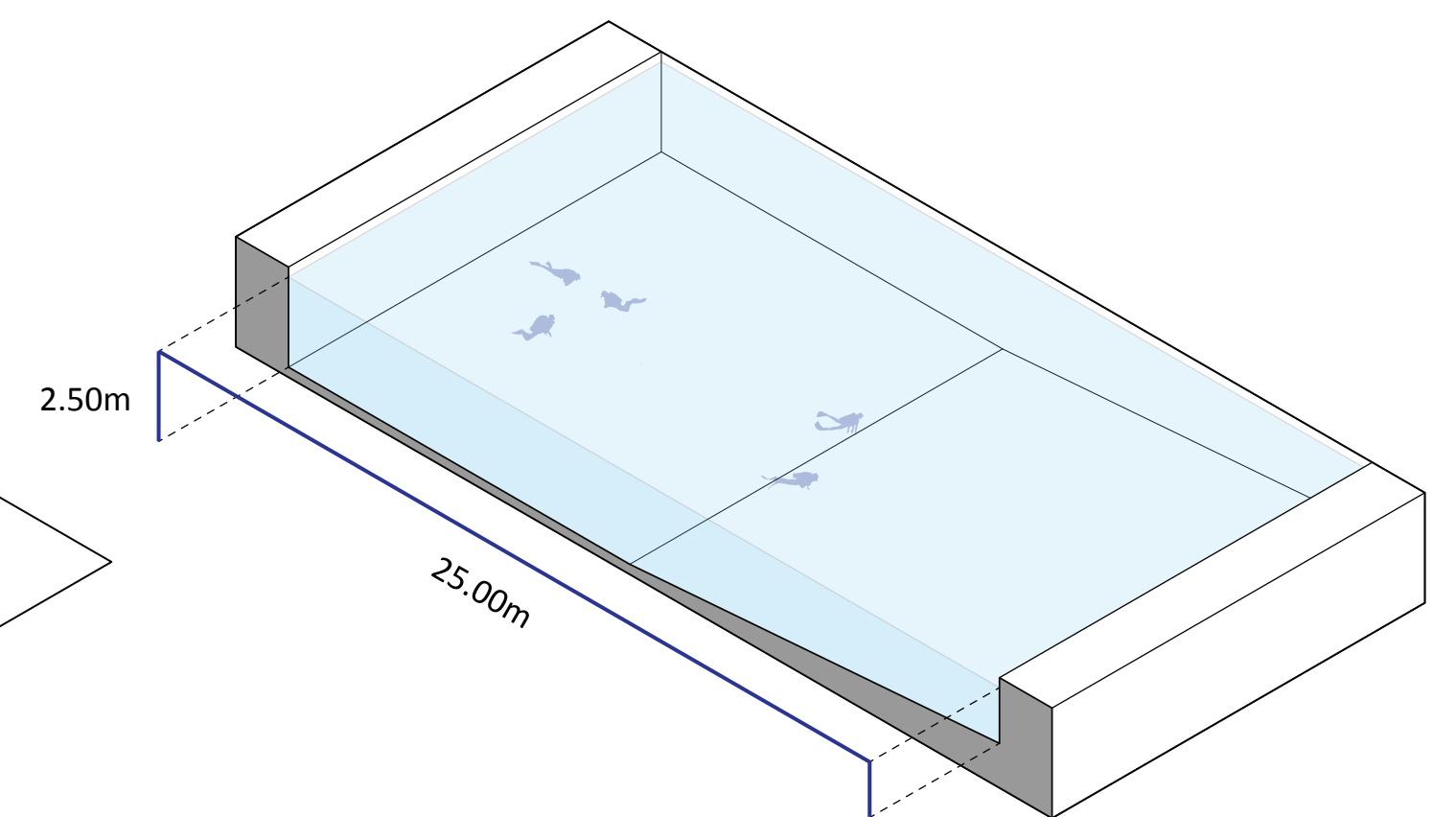

What activities can you only do in a 50m pool?

50m pools are great for competitive sports. They are able to accommodate long course races, and regulated water polo and synchronized swimming competitions. These are the only activities that cannot be accommodated in a 25m pool.

Race! 50m Long Course

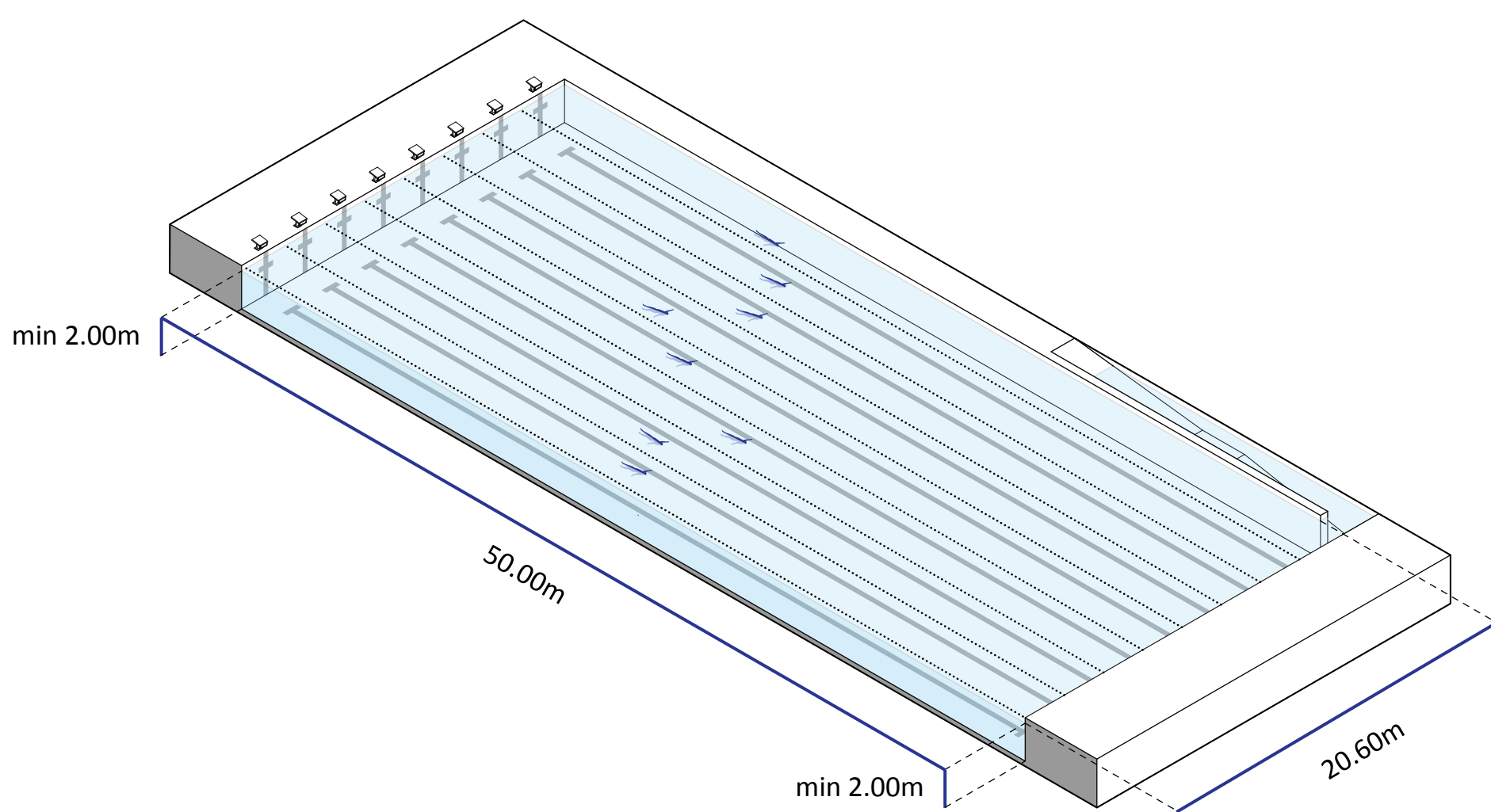

Play! Water Polo Competitions

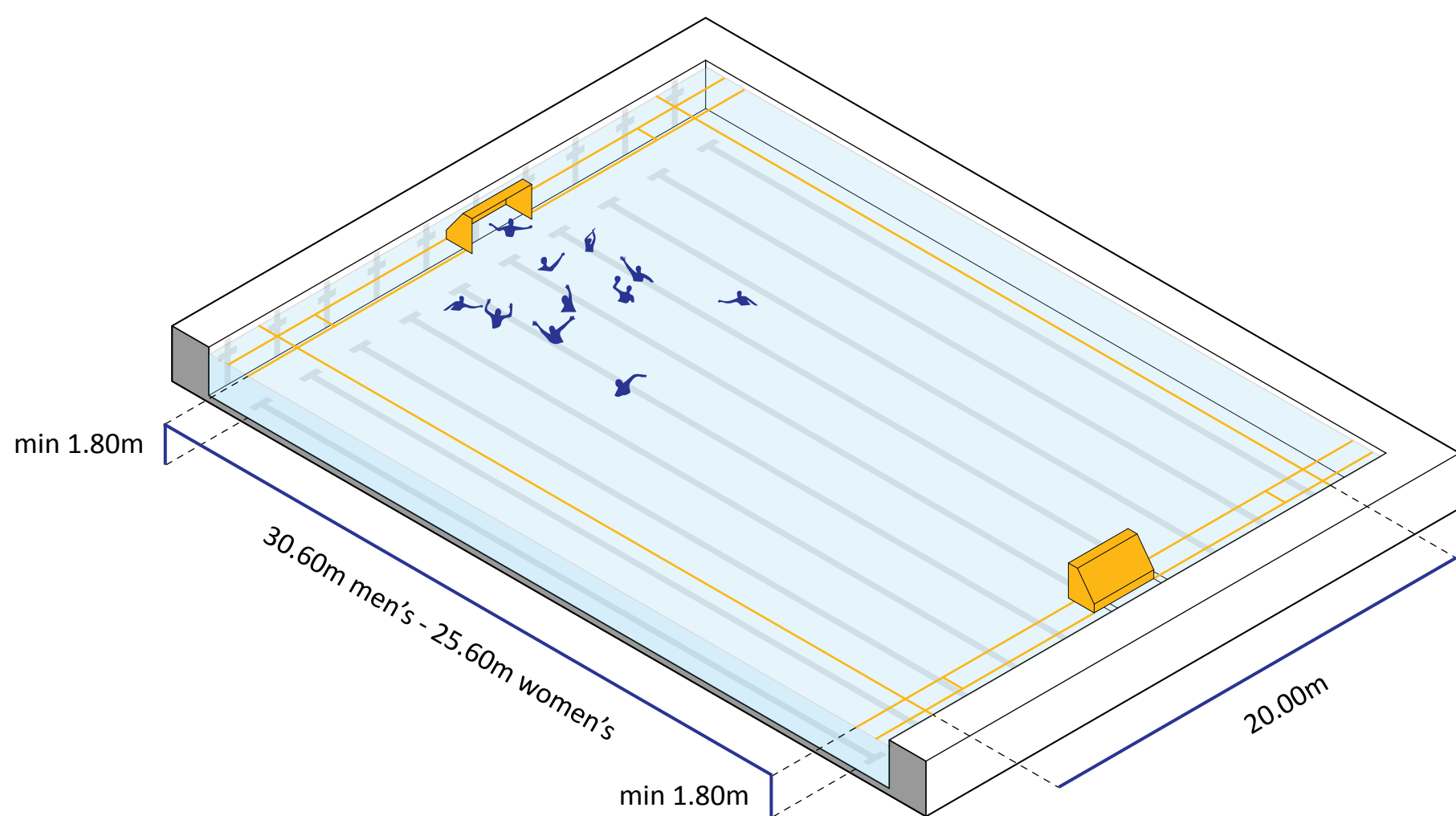

Dance! Synchronized Swimming Competitions

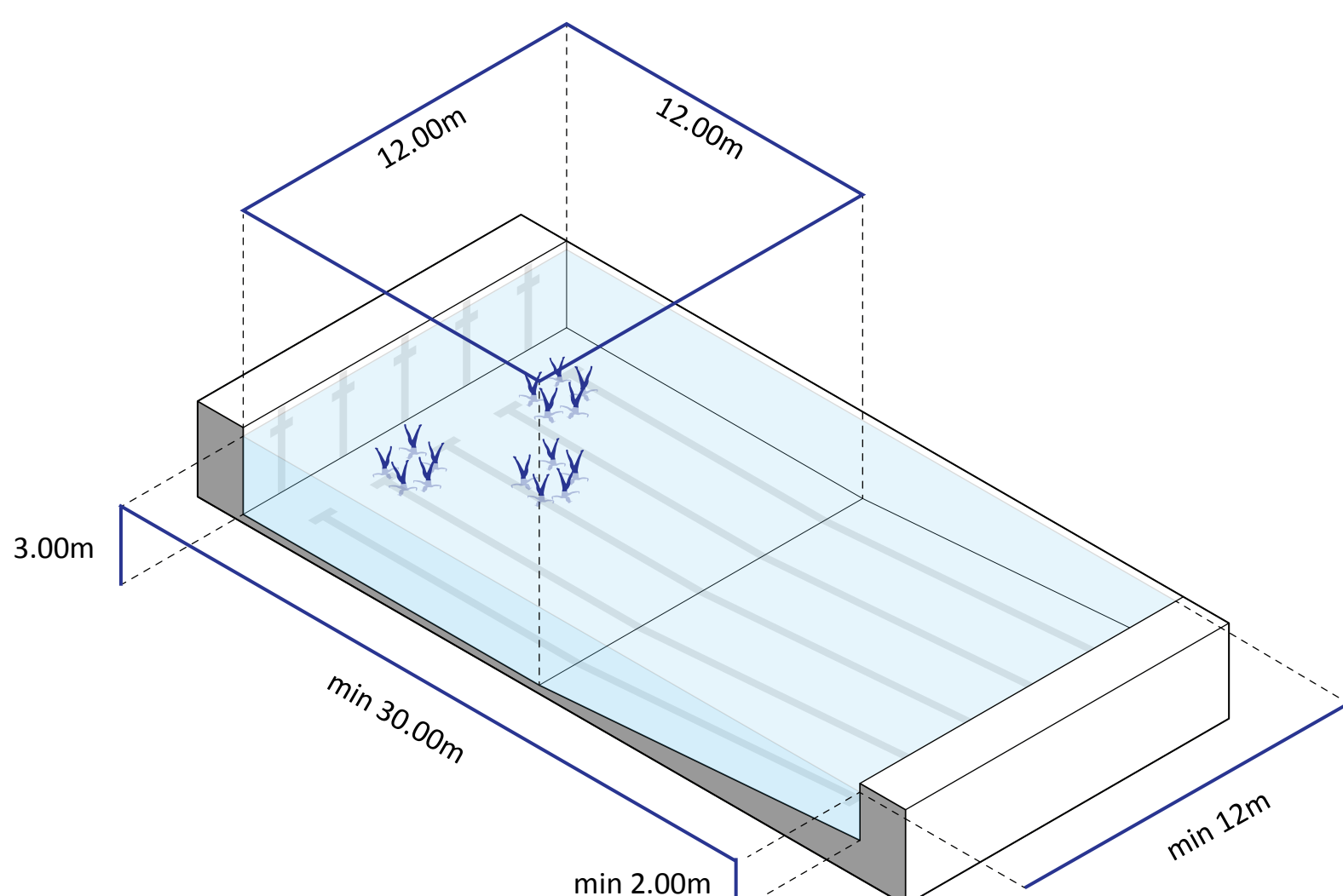

What does an aquatic centre need for competitions?

Electronic Scoreboard

(Swimming Canada, Facility Rules & Guidelines, Appendix C, Table 1)

Space for Judges

(Swimming Canada, Facility Rules & Guidelines, Appendix C)

Area for Spectators:

For provincial and national level events permanent seating is required for spectators. The area should accommodate between 200 - 750+ people for regional and provincial competitions respectively.

(Swimming Canada, Facility Rules & Guidelines, Appendix C, Table 1)

Pool Sizes:

Competitions can be held in both 25m and 50m pools. 25m pools are used for regional and club invitational events and 50m pools are required for provincial and national events.

(Swim Alberta, 2019 Facility Information and Design)

Space for Competitors:

Removable bleachers need to be supplied to accommodate between 100 swimmers for provincial events and 500+ swimmers for national events.

(Swimming Canada, Facility Rules & Guidelines, Appendix C, Table 1)

Warm-up Pool:

Warm-up space is required for large competitions. Provincial events require 6x25m lanes in an adjacent leisure pool and national events require a completely separate 8 lane 50m pool.

(Swimming Canada, Facility Rules & Guidelines, 2018, c 2.5.3)

There are a lot of regulations and standards that need to be met to certify an event with Swim Canada and Swim Alberta. These regulations typically require a great deal of extra space to fit all of the competitors, judges and spectators. The aquatic centre has to grow in every aspect to accommodate all of the additional people and spaces.



CITY OF YELLOWKNIFE

YELLOWKNIFE
Aquatic Centre



WWW.YELLOWKNIFE.CA/AQUATICCENTRE

MJMA

#AquaticCentreYK

What can you do in different pool sizes?

Aquatic Activities

RIMP Existing
25m Pool (6 Lane)
25m Pool (8 Lane)
50m Pool (6 Lane)
50m Pool (8 Lane)

Climbing Wall

Diving Board

Public Swim

Family Swim

Lane Swim

Aqua Jog

Swim Lessons

Aqua Adult

Aqua Fit

Lifeguard Training

Scuba

Underwater Hockey

Kayaking

Dragon Boat Racing

Pool Slide

Inflatable Obstacle Course

Retractable Obstacle Course

Lifesaving Sport Training

Lifesaving Sport Competition

Synchronized Swimming Training

Synchronized Swimming Competition

Women's Water Polo Training

Women's Water Polo Competition

Men's Water Polo Training

Men's Water Polo Competition

25m Competition Training

25m Competition (Local)

25m Competition (Regional)

50m Competition Training

50m Competition (Local & Regional)

50m Competition (Provincial)

50m Competition (National)

	RIMP Existing	25m Pool (6 Lane)	25m Pool (8 Lane)	50m Pool (6 Lane)	50m Pool (8 Lane)
Climbing Wall	●	●	●	●	●
Diving Board	●	●	●	●	●
Public Swim	●	●	●	●	●
Family Swim	●	●	●	●	●
Lane Swim	●	●	●	●	●
Aqua Jog	●	●	●	●	●
Swim Lessons	●	●	●	●	●
Aqua Adult	●	●	●	●	●
Aqua Fit	●	●	●	●	●
Lifeguard Training	●	●	●	●	●
Scuba	●	●	●	●	●
Underwater Hockey	○	●	●	●	●
Kayaking	●	●	●	●	●
Dragon Boat Racing	●	●	●	●	●
Pool Slide	○	●	●	●	●
Inflatable Obstacle Course	○	●	●	●	●
Retractable Obstacle Course	○	●	●	●	●
Lifesaving Sport Training	●	●	●	●	●
Lifesaving Sport Competition	○	●	●	●	●
Synchronized Swimming Training	○	●	●	●	●
Synchronized Swimming Competition	○	○	○	●	●
Women's Water Polo Training	○	○	●	●	●
Women's Water Polo Competition	○	○	●	○	●
Men's Water Polo Training	○	○	●	●	●
Men's Water Polo Competition	○	○	○	○	●
25m Competition Training	●	●	●	●	●
25m Competition (Local)	●	●	●	●	●
25m Competition (Regional)	○	○	●	○	●
50m Competition Training	○	○	○	●	●
50m Competition (Local & Regional)	○	○	○	○	●
50m Competition (Provincial)	○	○	○	○	●
50m Competition (National)	○	○	○	○	●

○ Requires 6 x 25m warm up lanes

● Requires 10 x 54m pool with additional 8 x 25m warm up pool



YELLOWKNIFE
Aquatic Centre



WWW.YELLOWKNIFE.CA/AQUATICCENTRE

MJMA

#AquaticCentreYK

How big will Yellowknife's new aquatic centre be?

A new aquatic centre with a 25m or 50m pool will be substantially larger than the existing Ruth Inch Memorial Pool. As shown in the diagrams below, support spaces like changerooms remain relatively the same size between the 25m and 50m pool options, with the most significant size variable being the lane pool itself. For a 50m pool to accommodate provincially or nationally certified events, however, additional deck and spectator space would be required – as well as additional warm-up space, depending on the event.

- Natatorium (Pool Room)
 - Change Room & Washrooms
 - Classroom & Multipurpose
 - Admin
 - Public
 - Mechanical & Storage
 - 100 People
- Sizes are approximate*

Example 25m Pool

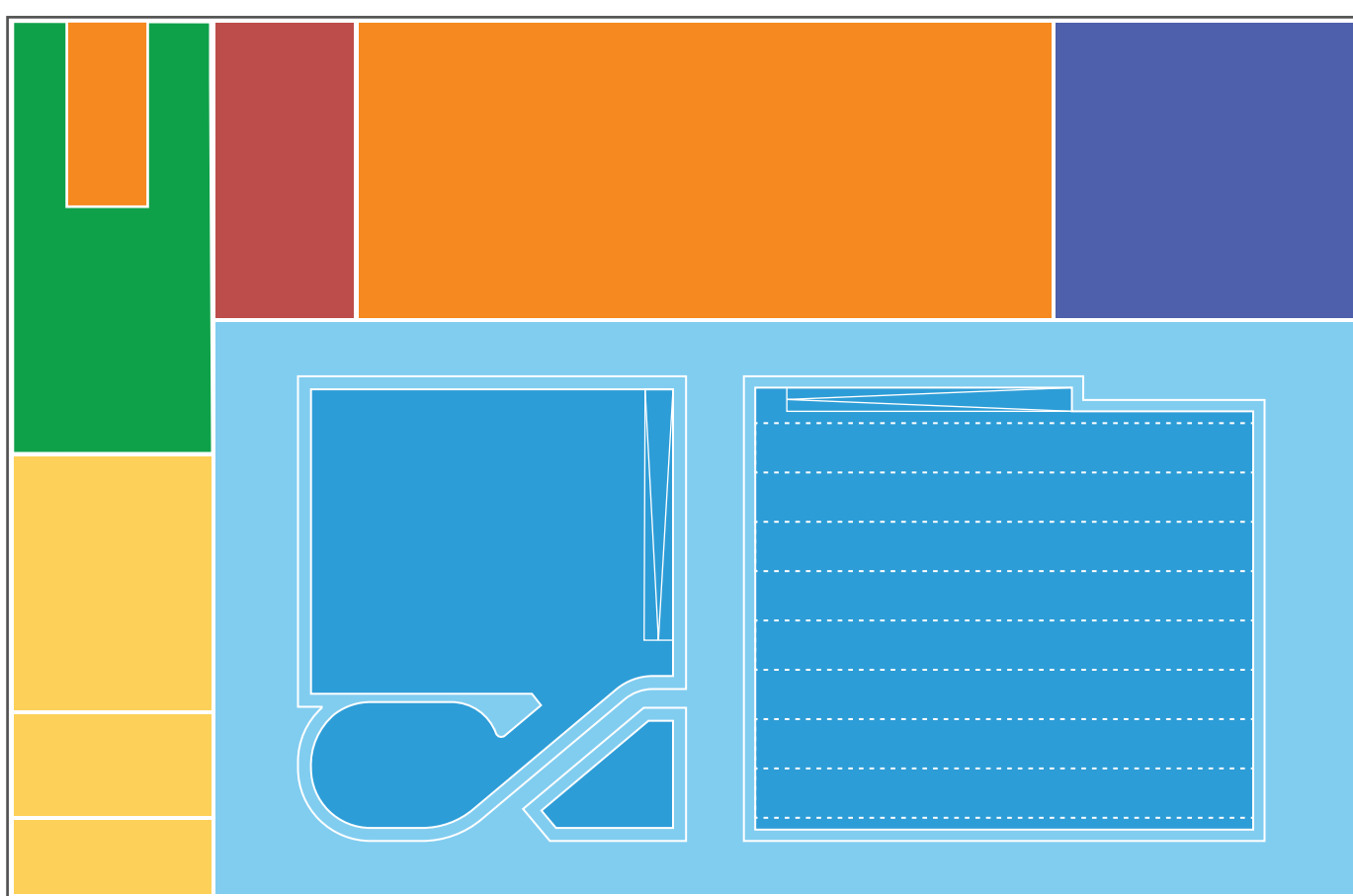

Gross floor area: 3,100 m²

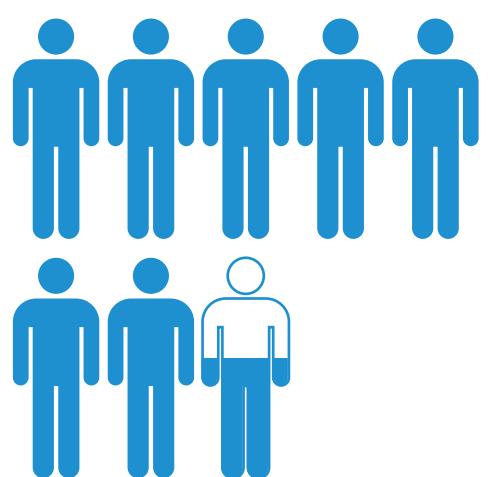

Total Pool Capacity

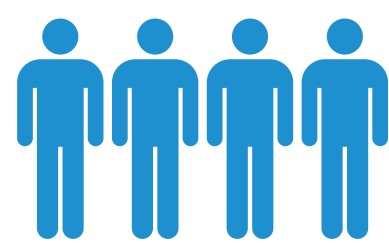

Leisure & Therapy Pool Capacity

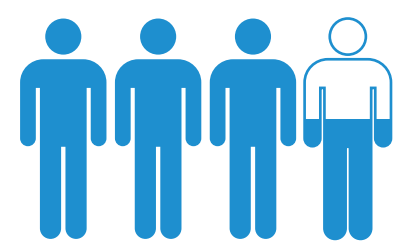

Lane Pool Capacity

Example 50m Pool

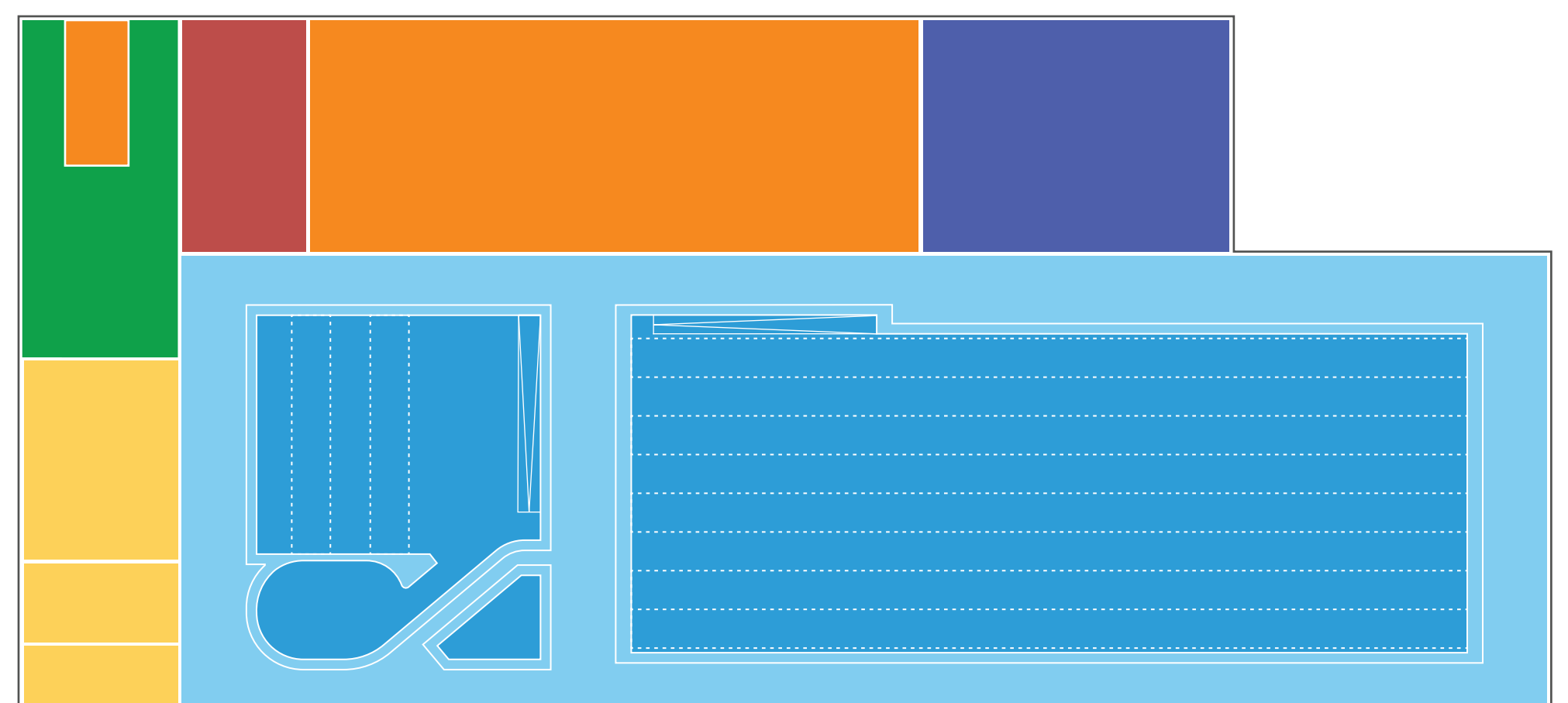

Gross floor area: 4,100 m²

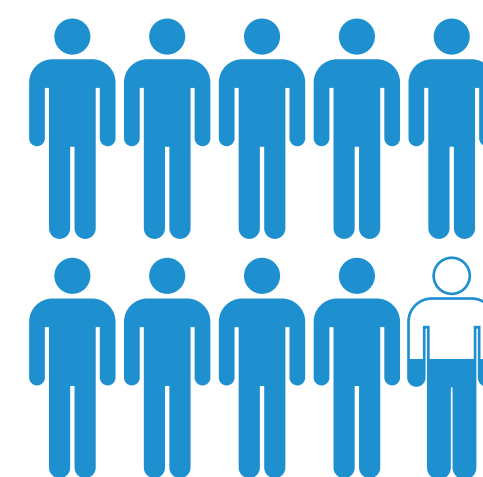

Total Pool Capacity

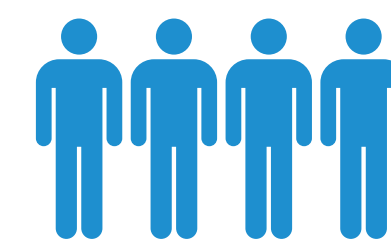

Leisure & Therapy Pool Capacity

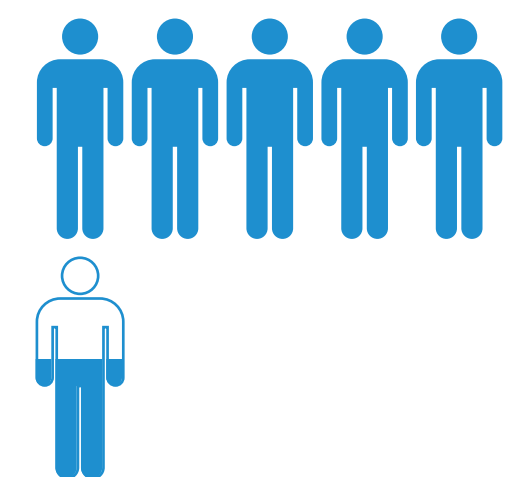

Lane Pool Capacity

Ruth Inch Memorial Pool

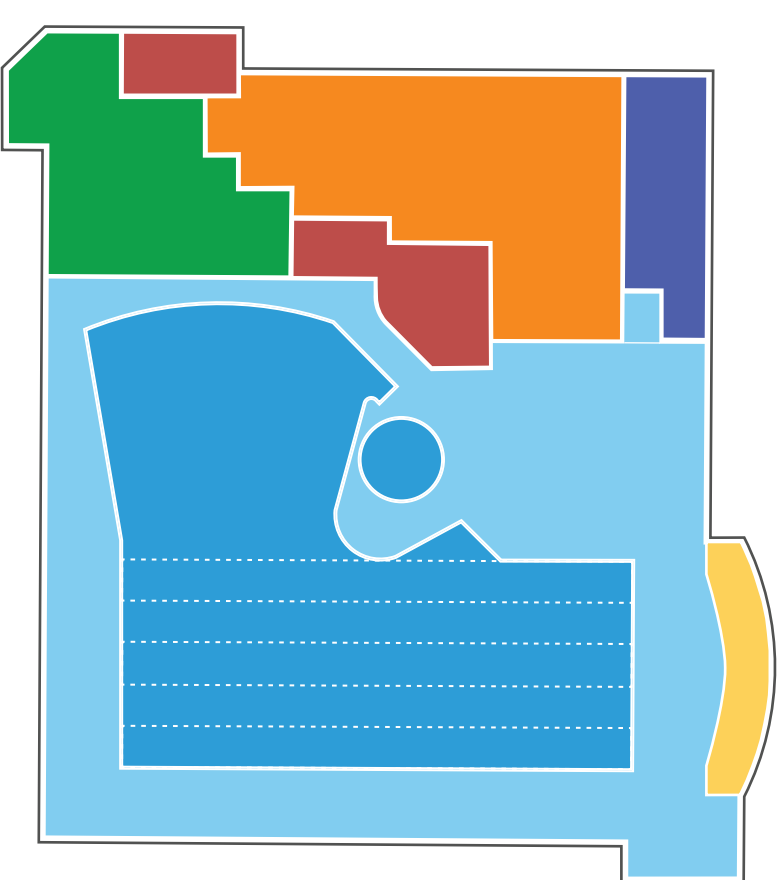

Gross floor area: 1,900 m²

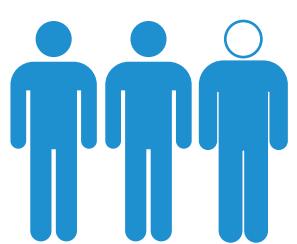

Total Pool Capacity

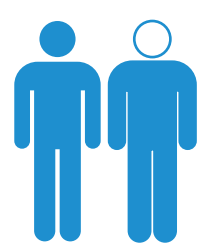

Leisure & Therapy Pool Capacity



Lane Pool Capacity

Course Enrollment VS. Course Capacity

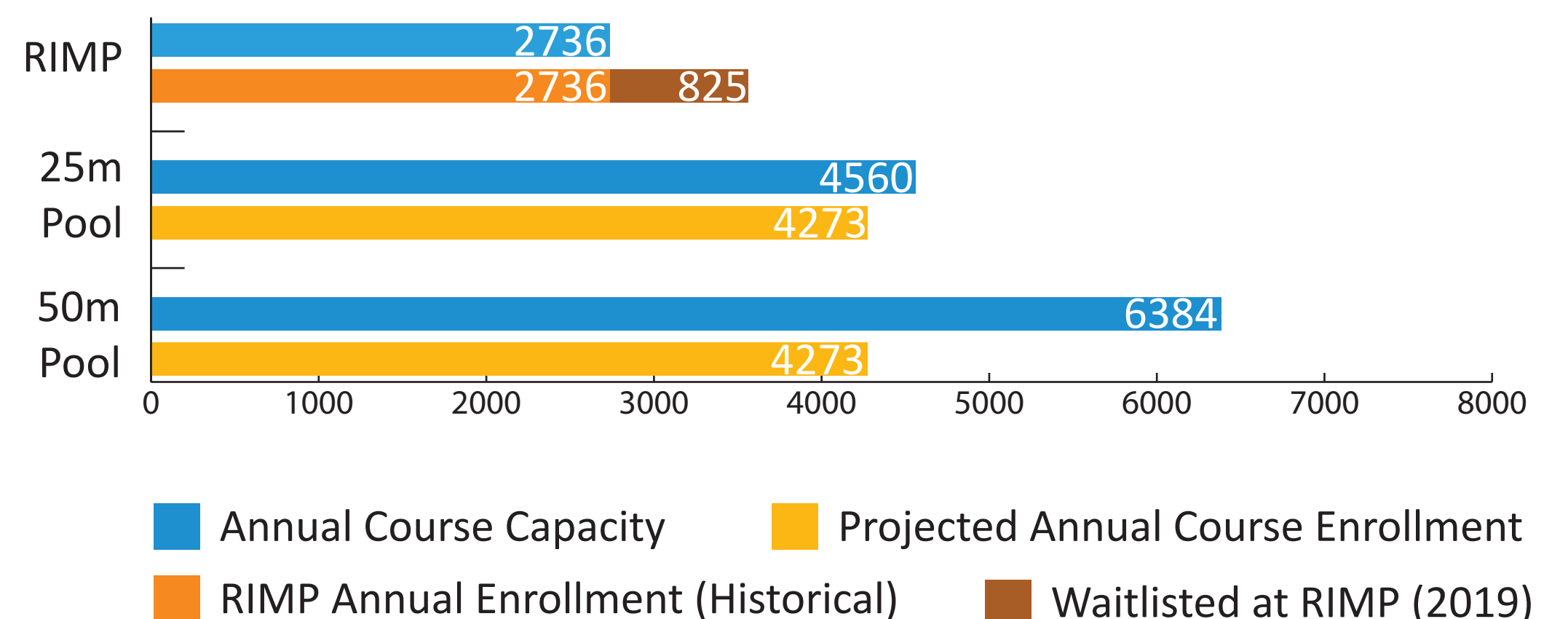

Current demand at RIMP outweighs the capacity of the facility. A new 25m pool would have an additional 22% (est.) enrollment capacity above the current demand. A new 50m pool would have an additional 44% (est.) enrollment capacity above current demand.

What will an aquatic centre cost?

Construction costs for different pool sizes: estimated range

The margin of error on the estimates shown here is +/-25%, because the project is in early stages. Cost estimates will become more refined as the design is further developed.

■ paid by Federal grant
■ paid by Yellowknife

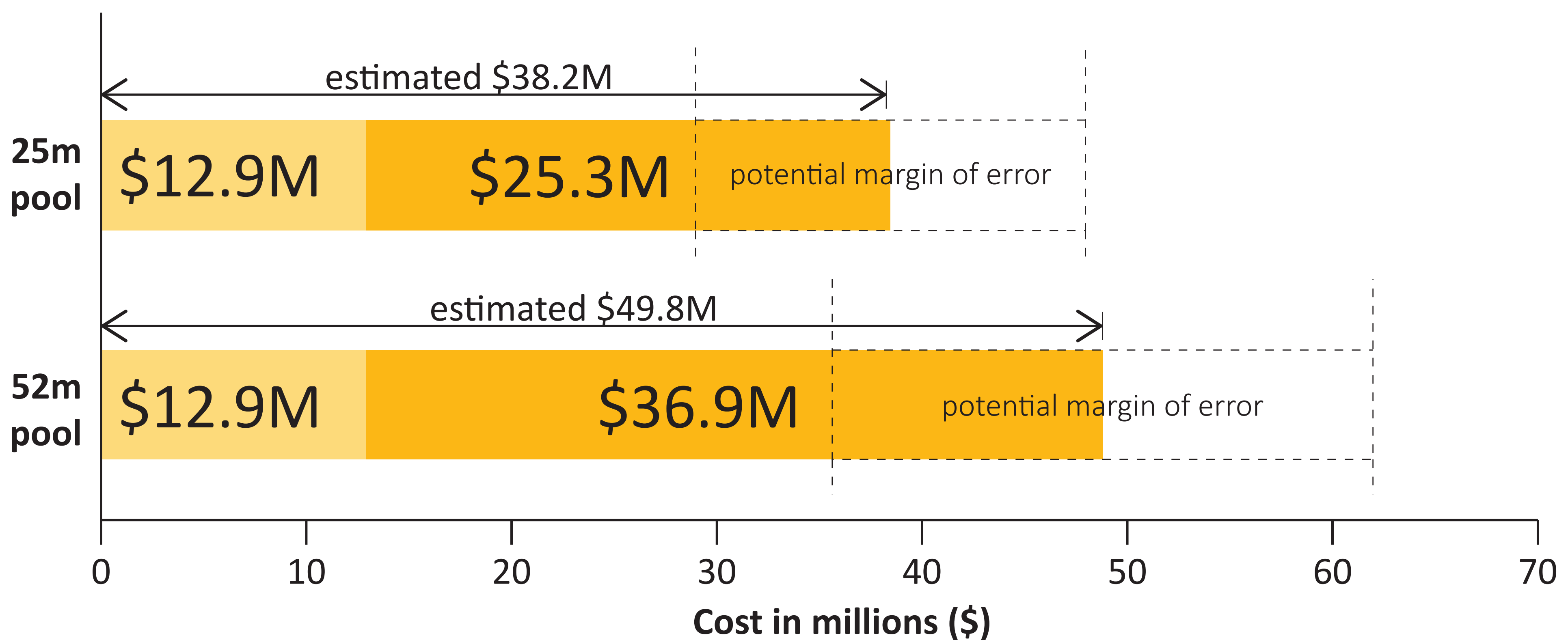

Annual Net Operating Expense (projected)

These estimates are based on numbers provided by the City of Yellowknife. A margin of error is applied to each projection, as some variables for facility operations have yet to be determined.

	2022 Projections for RIMP	Projections for 25m pool	Projections for 52m pool
Revenue	\$ 662,072	\$943,894	\$1,138,224
Expenses	\$ 1,940,094	\$2,772,505	\$3,481,920
Net operating expenses	\$1,278,022	\$1,828,611	\$2,343,696
Recovery (estimated)	34%	34%	33%

estimated tax increase to subsidize operations:

	25m pool	52m pool
Estimated tax increase	1.8%	3.6%



YELLOWKNIFE
Aquatic Centre



WWW.YELLOWKNIFE.CA/AQUATICCENTRE



#AquaticCentreYK